

Typography and Printing

Susanne Schulz-Falster Rare Books
Antiquariat Michael Banzhaf

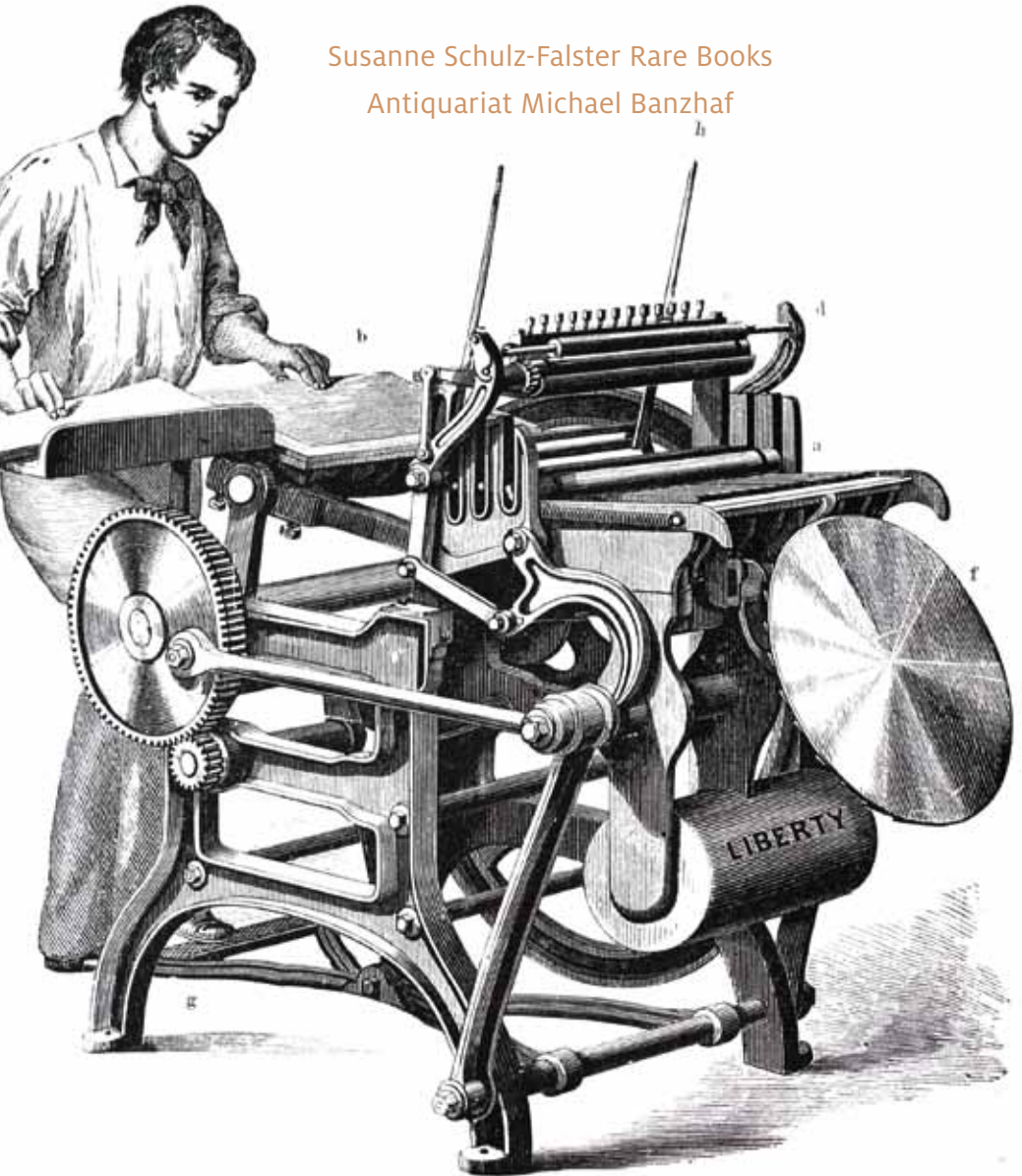



Susanne Schulz-Falster

RARE BOOKS

Susanne Schulz-Falster
22 Compton Terrace
London N1 2UN
Telephone 0044 - (0)20 - 7704 9845
Email: sfalster@btinternet.com
www.schulz-falster.com

ANTIQUARIAT BANZHAF

Antiquariat Michael Banzhaf
Moempelgarter Weg 17
D - 72072 Tuebingen
Telephone: 0049 - (0)7071 - 552314
Fax: 0049 - (0)7071 - 552315
Email: Antiquariat-Banzhaf@t-online.de
VAT. No. DE 147 148 385
www.antiquariat-banzhaf.de





I The first book-length type specimen printed in Italy
 Brogiotti, Andrea. *Indice de caratteri, con l'inventori, & nomi di essi, esistenti nella Stampa Vaticana, & Camerale. All' Ill.mo & R.mo Sig Francesco Card. Barberino.* Rome, [Stampa Vaticana e Camerale], 1628. ll. 74 (i.e. 72), printed on rectos only, title in red and black with woodcut Barberini arms, pagination includes 68 pages of type specimens, and four pages of music, one also printed in red and black; very faint trace of damp to margin of first signature; contemporary full vellum over boards, Spanish lettering along the spine, ownership inscription to title of Enea Corradini; a fine copy.

€ 12000.00

Bigmore & Wyman 1, 84; Birrell & Garnett 2; Blades, p. 14; Jammes 10; Mosley, p. 84; Updike I pp. 166-168; see also the facsimile with extended introduction by H.D.L. Vervliet (1967). First edition of the first book-length type specimen to be published in Italy. The 'Indice' is among the most interesting specimens in the history of printing, and shows the material of a seventeenth-century Italian printing office at its simplest and best' (Updike I, pp. 168 ff). Brogiotti was director of the *Stamperia Vaticana*, which evolved out of the *Typographia Apostolica Vaticana* (the learned press) and the *Stamperia Camerale*, responsible for printing official documents. He gives information on the origin of the type faces before presenting first a series of woodcut alphabets, then those in metal type. He first shows the older faces (mostly French) followed by the newer ones of Italian origin, such as those designed by Granjon during his time in Rome and later typefounders. In each case he indicates they origin. Included are Hebrew, Arabic, Cyrillic, Gothic Greek and Latin alphabets, together with four specimens of plain-song music types.





2 Etching and engraving in Portugal – first Portuguese translation of Bosse’s engraving manual

Bosse, Abraham. *Tratado da Gravura a agua forte, e a buril, e em maneira negra com o modo de construir as prensas modernas, e de imprimir em talho doce*. Nova edição traduzida do francez ... por José Joaquim Viegas Menezes. Lisbon, Arco do Cego, 1801.

Tall 8vo (208 x 152 mm), engraved title, pp. [x], ix, [1], 189, [1] errata, with 21 engraved plates; plates printed on slightly darker stock; a wide-margined clean copy in recent full calf, gilt.

€ 2000.00



Innocencio IV, 415; Moraes p. 11; see Bigmore & Wyman I, 72 and Cicognara 255 for French edition. First Portuguese translation of Bosse’s classic introduction to copperplate etching and engraving, *Traité des manières de graver en taille douce*. This Portuguese translation by José Joaquim Viegas Menezes is clearly taken from the Jombert edition and reproduces the same plates, though newly engraved with subtle adaptations; an extensive introduction precedes the text.



3 With Bonnet's instructions on colour printing

Bosse, Abraham. De la Manière de Graver a l'Eau forte et au Burin. Et de la Gravûre en Manière noire.

Avec la façon de construire les Presses modernes, &

d'imprimer en Taille-douce. Nouvelle Édition, Augmentée de l'Impression qui imite les tableaux, de la Gravure en maniere de crayon, & de celle qui imite le lavis. Enrichie de vignettes & de vingt-une Planches en taille-douce. Paris, Charles-Antoine Jombert, 1758 [vere ca 1773]. Tall 8vo (196 x 120 mm), engraved frontispiece, pp. xxxii (including engraved dedication), 205, [3] privilege, with four finely engraved vignettes (one after Cochin, and one after Bosse), 21 engraved folding throw-out plates; contemporary full catspaw calf, spine decoratively gilt in compartments, gilt-lettered spine label; expert repair at head of upper joint; a fine crisp copy.

€ 2800.00

Bigmore & Wyman I, 72; Cicognara 255; see En Français dans le Texte, 92; see Arthur M. Hind, 'A note on C.N. Cochin's second revision of Abraham Bosse's Traicté des manières de graver', Burlington Magazine (1907), p. 390 ff. Second Jombert edition (and fourth edition in all) of Bosse's Traité, with extensive additions on colour printing, dated 1758 but in fact apparently printed in 1773 (see below). This fourth edition adds two new plates by Louis-Marin Bonnet, the inventor of the Crayon manner of colour printing and a separate chapter on this method of colour printing. As for the date of publication, Arthur M. Hind argues that due to a number of references in the text and the citing of the 'gravure' article in the Encyclopédie the date of publication has to be some fifteen years later than stated both on the title and the imprint. In addition to a wealth of technical information, the work includes scenes of the engraving studio and the copperplate press, and several wonderfully informative step-by-step scenes of printmakers at work appear as engraved headpieces at the start of each new chapter (one of them a copy of Bosse's large plate of 1643). As adaptations were made to all subsequent editions, the work has remained an important introduction to print-making which is of practical use to the printmaker even today.



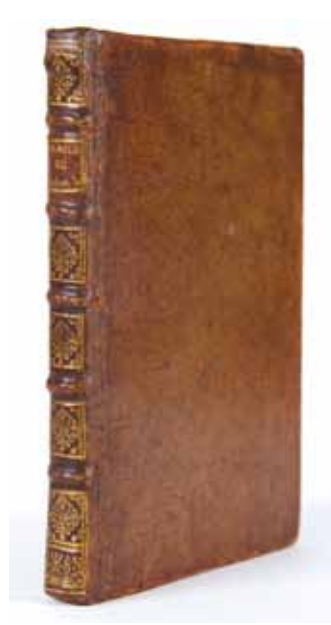

4 Bosse's printing & engraving manual

Bosse, Abraham. *Traité des Manières à graver en taille douce sur l'Airain, par le Moyen des Eaux Fortes & des Vernis durs & mols. D'Imprimer les Planches, & de construire la Presse*. Paris, [Aubouin & Clousier] paste-over label: Paris, Claude Jombert, 1701. 8vo, engraved title, engraved frontispiece, pp. [viii], 70, [2] with 16 numbered engraved plates, and two unnumbered plates, i.e. engraved dedication and unnumbered plate signed by Ertinger; contemporary full calf, spine gilt in compartments, extremities a little rubbed, discreet repair to lower corner.

€ 3000.00



See Bigmore & Wyman I, 72; Cicognara 254; see *En Français dans le Texte*, 92; for LeClerc see *Colour Printing with the Crayon Method* Thieme/Becker XXII, p. 523. First LeClerc edition of Bosse's manual of etching, engraving and printing. Bosse's treatise was aimed both at the professional engraver and at the amateur and is extensively illustrated, with detailed engravings based on Bosse's own designs. Subsequent editions, the present one by LeClerc and a further one edited by Cochin, are all valuable in their own right as they reflect changes in printing and engraving technique. This LeClerc edition has one extra plate and a newly written chapter explaining the use of the shallow etching bath.



INSTRUCCION
 PARA
 GRAVAR EN COBRE,
 Y PERFECCIONARSE
 en el gravado à buril, al agua fuerte,
 y al humo,
 CON EL NUEVO METHODO
 de gravar las planchas para estampar en co-
 lores, à imitacion de la Pintura;
 Y
 UN COMPENDIO HISTORICO
 de los mas célebres Gravadores, que
 se han conocido desde su invencion
 hasta el presente.
 DEDICADA
 A LA REAL ACADEMIA
 DE SAN FERNANDO
 POR DON MANUEL DE RUEDA,
 Comissario Extraordinario del Estado
 Mayor de Real Artilleria.
 Con Privilegio. Madrid, por Joachin Ibarra. 1761
 Se hallará en la Libreria de Manuel Ignacio de Foye
 entre de abacha, junto à la aduana.

5 Early Spanish colour printing

Rueda, Manuel de. Instruccion para gravar en cobre, y perfeccionarse en el gravado à buril, al agua fuerte, y al humo, con el nuevo methodo de gravar las planchas para estampar en colores, à imitacion de la pintura; y un compendio historico de los mas célebres gravadores, que se han conocide desde su invencion hasta el presente. Madrid, Ibarra, 1761. 12mo, 12 partly folded engraved plates, pp. [xxxii], 230; contemporary half calf, spine lettered in gilt; edges a little worn.

€ 5800.00

Bigmore & Wyman II, 278. UCBA II, 1791. First edition. A detailed manual on engraving, of special interest is a section on colour printing on pages 167 to 192 after the method of Le Blon illustrated with one plate. Some marginal foxing else a nice copy of a scarce book.





6 Model for 18th century commercial hand-writing

Snell, Charles. *The Art of Writing; in it's Theory and Practice.* by Charles Snell, writing Master at the Free Writing-School in Forster-Lane, London: with whom youth may board. George Bickham, sculpsit. London, Henry Overton, 1712. [bound with:] *The standard rules of the round and round-text-hands: mathematically demonstrating how better alphabets of those hands may be performed than have ever yet been published in Great Britain.* London, Henry Overton, 1723. Two works in one volume. Oblong folio (217 x 350 mm), engraved portrait bound as frontispiece, pp. [iv], v, [1] advertisement, engraved title, engraved dedication, and 25 engraved plates (numbered 4–8); [iv], viii, and six engraved plates (A to F); some light browning, the advertisement and engraved title shaved at foot; nineteenth-century half vellum over marbled boards, gilt-lettered red morocco spine label.

€ 3300.00

I. ESTC t139398; See A. Heal, *The English writing masters*, 1931, p. 161; II. this issue not found in ESTC, see ESTC n23247 for the 1717 edition. Two engraved writing manuals by the highly successful writing-master Charles Snell and engraved by George Bickham, first edition of the first work, unrecorded edition of the second. Charles Snell (1667 - 1733) was for many years London's most prominent writing master and accountant. He was highly influential in replacing Puritan flourish with a plainer and more efficient round hand, which set the standard for commercial handwriting in the eighteenth century, 'his practice and teaching of a simpler and standardized mode of handwriting most effectively met the need of clerks in the growing number of commercial houses. This is his principal claim to fame' (Oxford DNB). The second work, *The standard rules of the round and round-text-hand*, was first published in 1715, the present edition is unrecorded. Here Snell gives a brief introduction to his standardized round-hand, both in the letterpress text and in the engraved plates, which clearly outline the strength and thickness of strokes for forming legible letters and figures.



7 Unrecorded calligraphy manual

Duval, Nicolas. *Nouvelles Ecritures de Finance & italienne batarde, en usage avec un traité pour apprendre l'Orthographe par Nicolas Duval secrétaire ordinaire de la chambre du Roy & M. Escrivain juré à Paris*. Paris, Veuve Jean Henault & François Henault, 1674. Oblong small folio (196 x 310 mm), ll. [2] (engraved title and dedication), pp. 4, [1-]15, [1], 8 (letterpress text), ll. 20 (engraved text); engraved title with elaborate border, each engraved leaf with the text extended to form elegant calligraphic borders, the letterpress text often in columns, typographical rules; margins of plates showing evidence of old dampstains and fraying, the lower blank forecorner of title worn or torn with slight loss (not touching text) lately expertly repaired, the engraved border cropped at head with slight loss; limp vellum wrappers re-used from an earlier manuscript on vellum with traces of original text and various later scribbles and pen-tests; spine expertly repaired.

€ 5400.00

See Becker, 88 and 89 (editions of c. 1670 and after 1686), this issue not in OCLC or in any of the usual catalogues. Nicolas Duval was an influential figure in the development of French calligraphy and worked at the heart of the French government as *Secrétaire Ordinaire de la Chambre du Roy*. He issued a number of fine engraved manuals with differing sequences of plates and letterpress explanations and this example is apparently otherwise unrecorded. There does not appear to be any other work with the same title or, indeed, the same composition of text and plates. Surviving examples of these manuals are rare, and it is clear that Duval altered titles and contents to suit circumstances (perhaps on taking on a new student) so that each title may have been unique or issued in only very small numbers.





8 Printing Greek, Hebrew and Arabic – a guide for compositors

Oliveira, Custodio José de. *Diagnosis typografica dos caracteres gregos, hebraicos, e arabigos, addiccionada com algumas notas sobre a divisao orthografica da lingua latina, e outras da Europa, a que se ajuntao alguns preceitos da Arte Typografica para melhor correcção, e uso dos compositores, e aprendizes da Imprensa Regia.* Lisbon, Impressao Regia, 1804. 8vo, pp. [xvi], viii, 72, with pp. 4 of engraved plates showing ligatures and abbreviations bound after f4; numerous type specimens in the text; contemporary limp pattern paper boards; spine strengthened.

€ 1450.00

Bigmore & Wyman II, 90; Collins, *Catalogue Bonaparte*, 1981; Innocência II, 113.; Fonseca, *Aditamentos* 104; Monteverde 3822. First and only edition of this practical instruction manual for compositors when using Hebrew, Greek and Arabic alphabets, and the only Portuguese manual of typesetting. Alphabets and numbers of these languages together with their Roman letter equivalents are illustrated on the large number of tables and inserts in the text. Oliveira also includes explanations of formats and signatures, compositorial exercises and extensive information on Greek typography (in the form of a twenty-page footnote) together with four engraved plates showing ligatures and abbreviations of Greek.



9 Flügel, J(ohann) G(ottfried). *Literarische Sympathien oder industrielle Buchmacherei. Ein Beitrag zur Geschichte der neueren englischen Lexicographie. ... nebst einem Vorwort von Professor Dr. Gottfried Hermann.* Leipzig, Weichardt 1843. 8vo, pp. vi, 41; publisher's printed wrappers; wrappers dust-soiled.

€ 250.00

Kat. Bibliothek d. Börsenvereins dt. Buchhändler I, 496. First edition. Flügel published in 1847 and 1852 a „Praktisches Englisch-Deutsches und Deutsch-Englisches Wörterbuch“. In this pamphlet he strongly argues against other publishers of English-German or German-English dictionaries.





10 Unrecorded second (?) edition of a scarce Spanish type specimen

Espinosa de los Monteros y Abadia, Antonio. *Muestras de los caracteres que se funden por direccion de D. Antonio Espinosa de los Monteros y Abadia, academico de la Real de San Fernando, uno de sus primeros pensionados, en matrices hechas enteramente por el mismo, con punzones, que igualmente prosigue trabajando hasta concluir un surtido completo. No place, no date (Madrid, 1775?). 4to (205 x 148 mm), ll. [xxxvii] typefaces, of which 4 large folding; mostly within different borders; contemporary mottled calf; flat spine, richly gilt, head of spine defective.*

€ 4500.00

Udike II 80–81. Cf. Palau 184145 (only 24 leaves) and Birrell & Garnett 181. Probably second enlarged edition. On KVK there is a supposed 1770 edition (3 copies worldwide) with only 24 leaves. Our copy with an additional contemporary manuscript title-leaf “Fabrica nueva de caracteres de imprimir cuyos punzones y matrices inventa y graba D. Ant. Espinosa de los Monteros – Academico de las nobles artes y grabador principal de la Casa de Moneda de Segovia 1775”. “It shows a series of slightly condensed old style types which are remarkable in one respect – that roman characters in some cases, and italic in all, have an extraordinary quality of pen-work” (Udike, II, 81). A nice copy of an extremely scarce Spanish type specimen book.

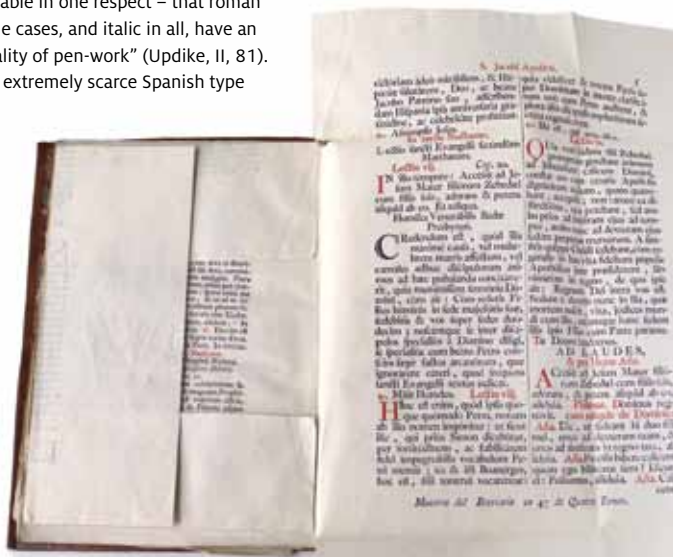

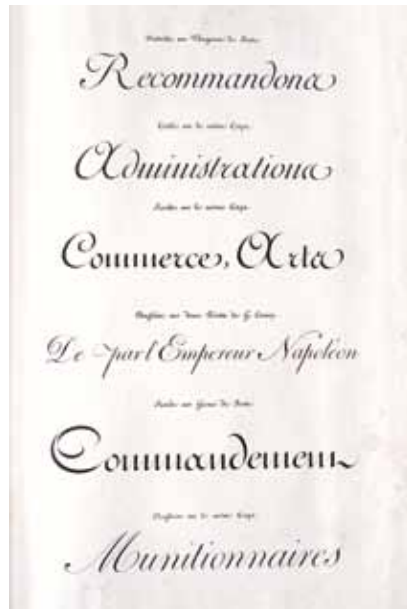

II Gillé's type specimen and sample book – for in-house use?

Gillé, Joseph-Gaspard. Extensive Type Specimen Sample Album, *Fonderie et Imprimerie J. Gillé*. Rue St Jean de Beauvais no. 28, Paris. Paris, Gillé, 1800 - 1813. Folio (430 x 290mm), album of ll. 50 of Gillé's typical wrappers printed on strong blue paper with classical decorative border; partially inserted, partially bound in are ll. 150 of type specimens, specimens of vignettes, decorative borders, advertising circulars, sample title pages etc.; bound in contemporary marbled boards, with red paper spine and corners, gilt-lettered red roan label to upper board, reading ,*Fonderie et Imprimerie J. Gillé, rue St. Jean de Beauvais, no 28, à Paris*'; binding rubbed and corners bent, but in very good condition.

€ 14000.00



See Audin 75-79; Birrell & Garnett 47; Gaskell, Barber & Warrilow, F9; Barber, *French Letterpress printing* p. 14; Fleuron 6, pp. 167 etc.; D.B. Updike, ,*A translation of the reports of Berlier & Sobry on Types of Gillé fils*. A fascinating type specimen album serving arguably both as a file copy and advertising tool for the firm of the Paris typesetter and printer Gillé fils. Gillé is particularly important as a promoter of the newer styles of ornament, offering typographic decoration to the printers of France, in a kind of stereotype, which he asserted was in design and method of reproduction destined to overthrow the outdated woodcuts of the ancien regime. (see Fleuron VI, p. 167 ff). The type specimen combines traditional forms of presenting new type faces,



Deux Types de Belle Venue
L'amitié est tellement rare que
Ce sentiment est communément
Deux Types de Gros Caract.
L'homme de bien mérite
Toutes recommandations
Deux Types de Gros Caract.
L'homme vertueux
Joseph Neveuville
Deux Types de Belle Venue
Commandant
Joseph
Imprimerie
Joseph
Fonderie



with 'promotional' literature, and an extensive range of borders and decorative devices. This type specimen has arguably been compiled within the firm of Gillé fils to provide an overview of his type specimens, advertisements and prospectuses published in the first decade of the nineteenth century. Amongst French type-founders at the end of the eighteenth and in the early years of the nineteenth century, the two Gillés, père et fils, held a prominent position. Gillé fils 'was not content to rest on his father's laurels after taking over the foundry in 1789. With the help of a workforce numbering between 80 and 100, he added substantially to his father's range of types and ornaments. He also made a considerable personal reputation by successfully combining artistic talent, commercial ambition, and the ability to keep himself well informed about technical developments in printing at home and abroad' (Dreyfus). Gillé produced a number of type specimens, bound normally in the wrappers which serve here as the dividers in the scrapbook. A number of these type specimens exist, all of them differ somewhat in their composition. This Gillé album includes not just the rarest items, such as the prospectus and a number of large folding type-specimen, but also some unrecorded examples. (a full listing is available on request).

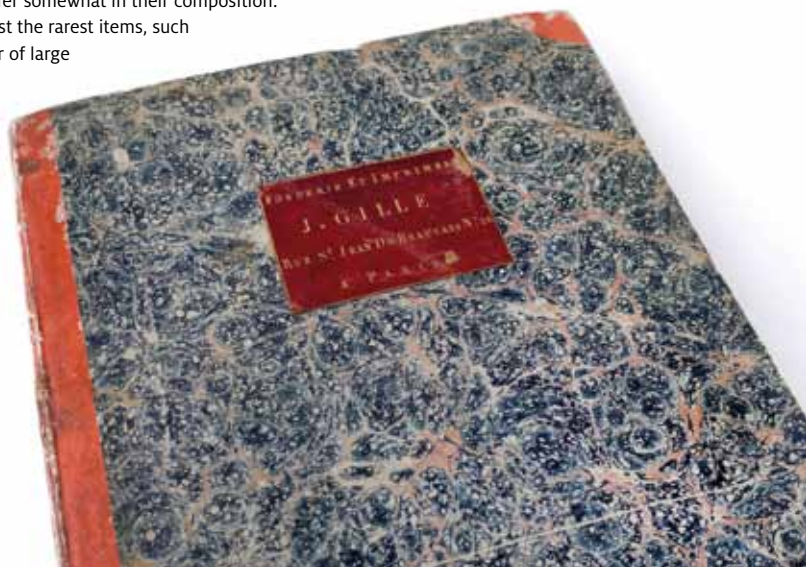

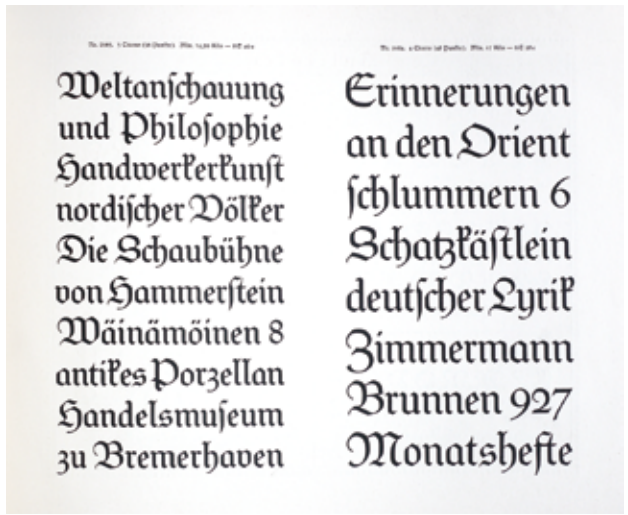

12 Weiss-Fraktur type specimen

Weiß, E(mil) R(udolf). Weiß-Fraktur. Die Schrift des Tempel-Verlages. Frankfurt, Leipzig, Barcelona und Madrid, Bauersche Gießerei (1913). Oblong- 4to. pp. 104 with various types, vignettes partly printed in colour, publisher's boards, printed paper label mounted to front cover, covers dust-soiled, spine-ends slightly damaged. € 250.00

Jolles 198. First edition.



13 New York private press

Corell Press. A Book to show certain goodlie types for printing in olde style. New York, Ye Corell Press, & ye Press of ye Classical School Associated Printers in ye olde style at University Place & Ninth Street in ye goodlie City of Neu Amsterdam (ca. 1895). 8vo (218 x 136 mm), pp. [xx] of type specimen; original printed blue wrappers, uncut. € 260.00

An obscure press which eventually moved to the tiny town of Mt. Washington, Mass. "This brochure is issued in accordance with the theory that the history of typography should, to a proper extent, govern the work of the modern printer" (preface). Slightly soiled.

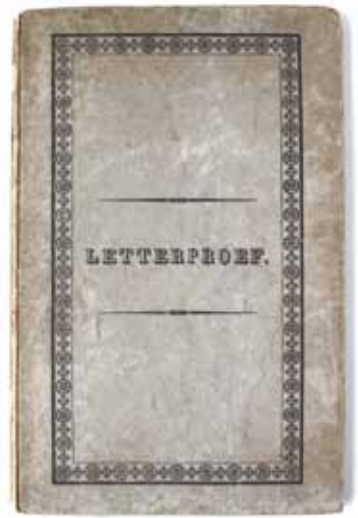

14 Early type specimen of the Arnhem printers C.A. Thieme

Thieme, Carl Albert. Letterproef der Boekdrukkery van C.A. Thieme, te Arnhem. Arnhem, [Thieme], 1830. Folio (320 x 205 mm), ll. 44 comprising title page, with small vignette showing a printer's studio, ll. 28 of types including music, 5 of 'Bloemen' (fleurons and rules), 1 of numbers, 1 of algebraic symbols and fractions, 3 of coats of arms of the Netherlands, and 5 of vignettes; original grey printed boards, the title on the upper board and a Stanhope press on the lower, both within fleuron borders, spine paper covering mostly worn off and clumsily lettered in manuscript, sides and corners a little soiled and worn.

€ 4400.00

Not in Bigmore & Wyman, Davis and Orioli or Jammes; not in John A. Lane et al, Dutch type founders' type specimen, 1998; OCLC lists Amsterdam University Library only; Marinus Anthonie Sipman, Drukkerij G.J. Thieme, Arnhem en Nijmegen, Thieme, 1913. Apparently only edition of this early type specimen of the Arnhem printers C. A. Thieme. The firm was founded by H.C.A. Thieme, who came to Zutphen in 1770 from Wesel in Germany. He married into a local printing firm, and his four sons continued the business, two in Arnhem, one in Nijmegen and one in Zutphen. The firm remained active well into the 20th century (see Handbook Concise History of the Printed Book in the Netherlands).





15 Italian provincial type specimen

Capriolo, Luigi. *Campione dei Caratteri, Vignette e Fregi della Tipografia Capriolo in Alessandria*. Alessandria, Luigi Capriolo, 1855. Tall 8vo, (200 x 148mm), ll. 171, all printed on one side only, within decorative border; occasionally a little browned, due to paper stock, and title page strengthened in gutter margin; contemporary full sheep, flat spine decorated and lettered in gilt, quite rubbed, joints weakening, but holding firm.

€ 2500.00

Not found in OCLC, not in St Bride catalogue, Mosley or Jammes. Very rare type specimen of the publishers and printers Luigi Capriolo in Alessandria, Italy. Thirty leaves of text type are followed ca. 60 ll. of display types of all shapes and sizes, 7 leaves showing typographic borders, and ca. 70 ll. of vignettes, including woodcut borders. About half the leaves are printed landscape. Particularly expressive are the display types, and bulked-up roman letters, 'fatface, shaded and decorated types'. The large size woodcut borders include architectural designs, but also figurative borders, similar to sixteenth century designs. The printers, publishers and booksellers Luigi Capriolo were active in Alessandria from the end of the 18th century.





r6 Proof copy

Oomkens, J & J. Zoon. Proef van Letteren, Bloemen, enz. der Boekdrukkery van J. Oomkens J. Zoon. Groningen, Oomkens, 1807. 8vo, ll. [iv], half-title, title and preface, followed by ll. [67] of type specimen, mostly printed within border of type ornaments, and including a large number of loose proof sheets, without signatures etc.; preserved in old boards, with lozenge-shaped printed label loosely inserted; a very fine and crisp copy.

€ 3200.00

Bigmore & Wyman II, 93; not in Birrell & Garnett; not in Jammes. Proof copy of the first type specimen of the printers J. Oomkens. Oomkens (1772 - 1851) states in his preface that after acquiring the printing house in 1802 he intended to publish a type specimen, but decided to hold back until he had built up a representative stock. This proof copy indicates his careful selection of suitable type faces, and the care with which he presented them. The type specimen not only gives a comprehensive overview of his display and text types, vignettes, borders and lines, but is particularly attractive, with every specimen printed within a different border of type ornaments. His son Alle van der Veen Oomkens (1814 - 1872) later added a type-foundry to the printing works. In addition to display type and text type, Oomkens includes Greek, Hebrew, Syriac, and Arabic letters. He offers a large selection of mathematical and commercial abbreviations, figures, fractions and superscript, almanac cyphers, and medical and alchemical symbols. The type specimen concludes with vignettes, fleurons, and typographical ornaments.

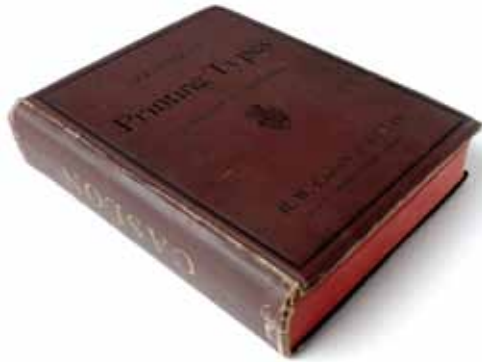

17 H. W. Caslon & Co Ltd. Specimens of types & borders and illustrated catalogue of printers' joinery and materials. 2 parts in one volume. London, Caslon, (1913). 4to (290 x 235 mm), frontispiece portrait of William Caslon, pp. I., [viii], 660; 126 with many text illustrations of printing materials; publisher's brown cloth, spine lettered in gilt, black title on front cover; all edges red; slight wear to edges.

€ 700.00

A massive type specimen book of this famous type foundry. The first part covers text type, poster and display type and numerous ornamental dashes, together with decorated borders and corners. With a loosely inserted 4-page price-list.





18 Spanish calligraphy

(Anduaga y Garimberti, José de). Arte de escribir por reglas y sin muestras, establecido de orden superior en los reales sitios de San Ildefonso y Valsain despues de haberse experimentado en ambos la utilidad de su ensenanza, y sus ventajas respecto del metodo usado hasta ahora en las escuelas e primeras letras.

Madrid, Imprenta Real de la Gazeta 1781. 4to (250 x 178 mm), pp. [iv], xxxix (1), 99, (5), 30 plates with 53 engravings; contemporary green Spanish morocco, spine richly gilt; sides with gilt fillets; a.e.g., marbled end-papers. Fine.

€ 6000.00

Cotarelo y Mori, Diccionario Biográfico y Bibliográfico de los Calígrafos Españoles, p. 101. Palau 12350 "De esta primera edicion no hemos visto ejemplar". Salva 2197. Bonacini 75. First edition, very rare. A large paper copy in a lavishly decorated contemporary Spanish binding.

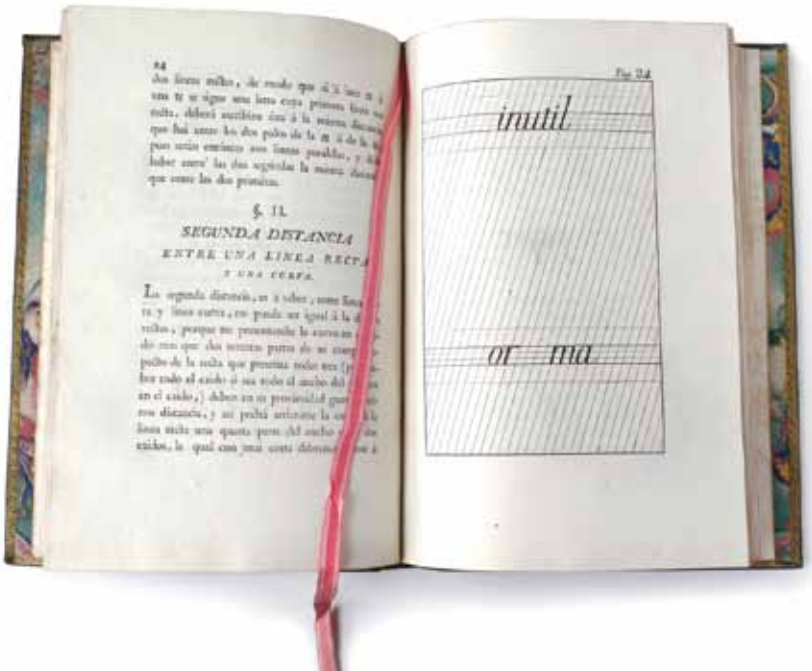

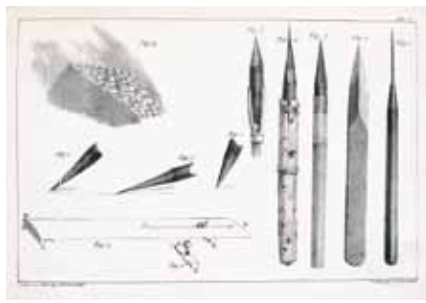

19 'The most important lithographic manual published in England'

Hullmandel, Charles. *The Art of Drawing on Stone*, giving a full explanation of the various styles, of the different methods to be employed to ensure success, and of the modes of correcting, as well as of the several

causes of failure. London, C. Hullmandel, R. Ackermann, [1824]. 4to, pp. [ii] lithograph title, xvi, vii, [1] blank, 92, [2] advertisement for various lithographic works, with 19 lithograph plates in various techniques (two with tinted background); uncut in recent pale blue boards; some light foxing and spotting due to paper quality; early ownership inscription to title by M. Leather; a good copy.

€ 1450.00

Bigmore & Wyman I, 349; Bridson & Wakeman D20; Jackson Burke 1025; Twyman, *Lithography*, p. 114. First edition of ,the most important lithographic manual published in England in the the first half of the century with the most explicit illustrated instructions for the artist working in the tonal style' (Bridson & Wakeman, p. 132.) Hullmandel had studied lithographic printing under Senefelder, the inventor of the process, and gives a thorough introduction to the technique of crayon drawing for lithography. His sufficiently high standards in printing attracted competent draughtsmen to draw on stone, and during the 1820s and 1830s he was responsible for making many important improvements to the printing process, which in turn was responsible for the success of lithographic printing in England. A full analysis of the work and its importance in making the lithographic printing process more popular is given in Twyman, *Lithography 1800-1850*, pp. 114-31. The plates include a map, samples of handwriting, demonstrations of techniques and effects, with one example in two colours.



20 P. Piette's copy with his printed label and additional manuscript material

Didot, Paul Firmin. *Nouveau mode de blanchiment*. (Paris, Firmin Didot frères 1855). 14 pages, one large folding engraved plate. – Together with: 3 contemporary large folding technical wash-drawings (ca 500 x 400 mm) on tracing paper with technical devices for the bleaching of paper-stuff and rags. Due to fragility of the paper with some tears in folds (but no loss of image). Contemporary cloth, gilt title to spine; covers soiled, with printed label of P. Piette to front fly-leaf.

€ 2600.00

Not in Weiss, *Papiergeschichte*. Garçon, *Bibliographie des industries tinctoriales* II, p. 205. Rieger II, 170. Bigmore & Wyman I, 180 (variant title). First and only edition. "Paul Firmin is the son of Hyacinthe. He was born in 1826, and has devoted much attention to chemical investigations, with the view of improving the manufacture of paper. He published jointly with M. Barruel „Un nouveau methode de blanchiment des chiffons et des plantes textiles, par l'adjonction du gaz acide carbonique“ in 8vo. This is a work which led to several improvements in the processes of paper-making, especially in the bleaching of rags and of paper-stuff made from fibrous plants“ (Bigmore & Wyman).

21 Magnificently printed by Didot for the education of the Dauphin

Massillon, Jean-Baptiste. *Petit Carême*. ... Imprimé par ordre du roi pour l'éducation de Monsieur le Dauphin. Paris, Didot l'aîné, 1789. Large 4to, woodcut-vignette on title, pp. [viii], 312, contemporary red morocco, flat spine richly gilt; frame gilt borders to covers; all edges gilt; marbled endpapers; printed bookseller ticket "Chez les Fr. Gay, St. Petersburg & Moscow" on front paste-down. Minor rubbing.

€ 2800.00

One of 200 copies. "Cette édition a été imprimée, au nombre de 200 exemplaires, avec les nouveaux caractères de la fonderie de Didot l'aîné, gravés par Firmin, son second fils, sur papier vélin de la fabrique de MM. Dervaud et Frères Henry, d'Angoulême" (from the prelims). One of the magnificently printed and bound works which were made by order of Louis XVI for the education of the Dauphin. The handful of titles were all limited to an edition of 200 copies, and were printed with the types cast by Firmin Didot on special paper 'velin', that the Didots first introduced in France in 1780. A fine broad margined copy in a decorative contemporary binding.

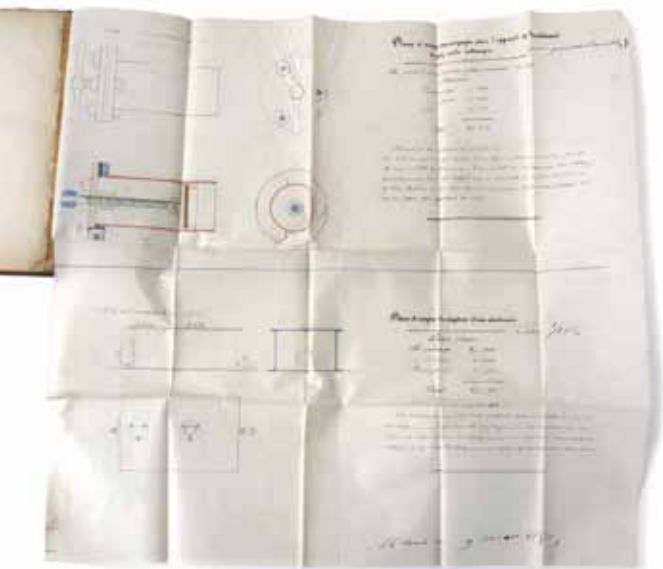
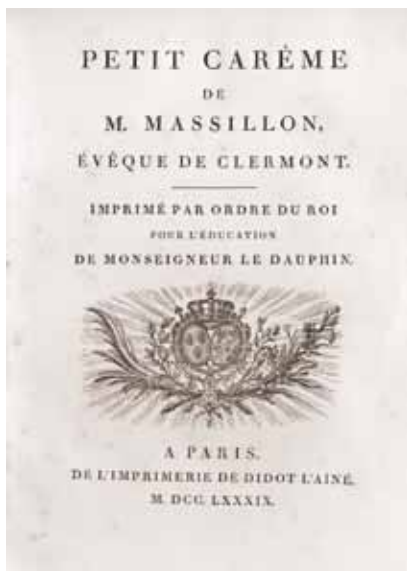



22 Urania type foundry

Urania. Catalogo articoli di Fonderia Caratteri di Testo Fantasie, Fregi e Fili in Ottone e Piombo, fusetti grappe ecc. Milan, Urania ca 1900. 8vo, pp. lxxviii, [2], 83, [1], 47, [1], 112; with some specimens in colour; original printed cloth. € 600.00

Fine type specimen of the little-known Milan type-foundry, founded in the early twentieth century. To strengthen its market share, it merged in 1908 with the Turin Nebiolo foundry in a kind of holding company, called Augusta. After the first world war, the firm which by now incorporated other type foundries too, was renamed Nebiolo type foundry, under which name it still exists today, though better known for producing printing presses. The type specimen includes a large selection of text and display types, some printed in colour, lines, borders, and devices.

23 Regulating the Italian printing industry

Printing – Law. Tabella che stabilisce il numero degli stampatori nel Regno. Milan, Reale Stamperia, 1812. Broadside (420 x 550 mm), printed on recto only, with arms of Eugenio Napoleone at head, printed in double columns, with table to lower half of broadside; foldmarks. For the French decree of 1810 see Carla Hesse, Publishing and Cultural Politics in Revolutionary Paris, 1789-1810, 1991. € 600.00

First edition of this decree on the regulation of printing in Italy, in particular the strict limitation of the numbers of printers licensed per town or city. This regulation passed in the Napoleonic Kingdom of Italy is basically an extension and adaptation of French rulings which had been passed in 1810.

After the expansion of the print and publishing market during the revolutionary years, a large number of printers and publishers faced bankruptcy in the early 19th century, due to lack of regulation, changes in copyright law, a wider availability of small presses, which had led to a flooding of the market, and general oversupply. Signed by secretary of state Antonio Strigelli (1755-1835), this decree limits the number of printers per community. The lower half of the broadside shows the number of printers allowed by department and per city. Whereas 18 printers were allowed for Venice and Milan, Verona and Bologna could have 6, towns like Padua and Brescia had to make do with 4, Modena and Novara with just two, etc. figures are given for 72 towns and cities of the Napoleonic Kingdom of Italy. Exceptions were made for specialist printers, such as those printing music or printing in foreign and exotic languages.



24 Lamesle's type specimen – from Updike's library

Lamesle, Claude. *Épreuves Générales des Caracteres* qui se trouvent chez Claude Lamesle Fondeur des Caracteres d'Imprimerie. Paris, Rue Galande, 1742. Small 4to, ll. 81, title and 80 leaves of type specimens, of which 10 are oblong in size, folded, and mounted on guards; title and music specimens printed in red and black; printed throughout within double border; contemporary full panelled calf, joints and corners expertly repaired; from the library of the well-known type historian D.B. Updike, with his ownership inscription in ink to title page; a wide-margined copy.

€ 4500.00

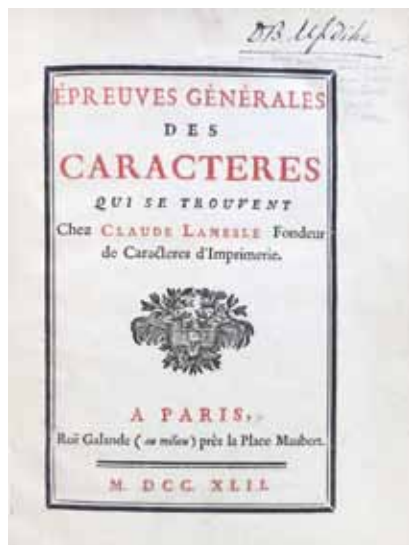

Audin, 27; Bigmore & Wyman I, 417; Birrell & Garnett 35; see A. F. Johnson, *The Type specimens of Claude Lamesle*, a facsimile edition of the first edition printed at Paris in 1742, Amsterdam 1965; John Dreyfus, *Aspects of French Eighteenth Century Typography*, Cambridge, Roxborough Club, 1982. First edition of Lamesle's first type specimen, a fine association copy of a splendid stock of types, containing examples of work by some of the finest French punchcutters, such as Peter Schoeffer the younger, Claude Garamond and Robert Granjon. 'Lamesle's specimen book of 1742 was meticulously planned, with much of the text used for the specimen settings running on continuously from roman to italic and from one size to the next. His types were consistently numbered from start to finish, with Greek and Hebrew included in the numeration. Ornaments, signs, titlings and initial letters of various sizes were shown at appropriate junctures in the sequence, making the book a very comprehensive and helpful guide to printers deciding what they needed to order from him' (Dreyfus). This copy comes from the collection of the American printer and historian of typography Updike who was fulsome in his praise: 'this book, both in type and ornaments, I think presents better than any other, the output of French foundries during the last quarter of the XVIIth and the first half of the XVIIIth century. The collection of types is remarkably fine' (Updike I, p. 270).

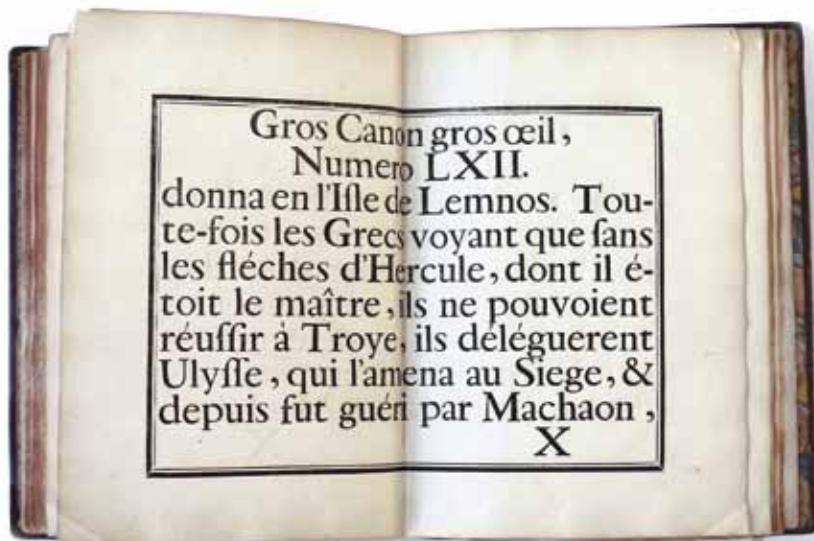



25 Playing cards and papermaking

Breitkopf, Johann Gottlob Immanuel. Versuch den Ursprung der Spielkarten, die Einführung des Leinenpapiers und den Anfang der Holzschnidekunst in Europa zu erforschen. Erster Theil, welcher die Spielkarten und das Leinenpapier enthält. Mit vierzehn Kupfertafeln. Leipzig, Breitkopf, 1784. 4to, pp. iv, 136, with 14 engraved plates, mostly folding; contemporary half sheep over paste-paper boards, spine in compartments, ruled in gilt; a good copy with modern ownership inscription to front free endpaper.

€ 1800.00

Bigmore & Wyman I, 81; St. Bride catalogue 8947. First edition of two extended illustrated essays on the history of printing by the eminent Leipzig printer and typographer Breitkopf (1719 - 1794), covering the history of playing cards and the origin of linen paper in Europe, and in particular in Germany. A third essay on woodcuts and their invention was to follow in 1801 and is not present here. This first part was clearly meant as an independent publication, with a detailed concluding subject and author index. Breitkopf gives a thorough history of playing cards, the origin of cards, their iconography, and their printing. The second essay covers papermaking, both from cotton and linen, and its distribution and development in various European countries. Both essays are accompanied by very detailed bibliographical references and annotations.

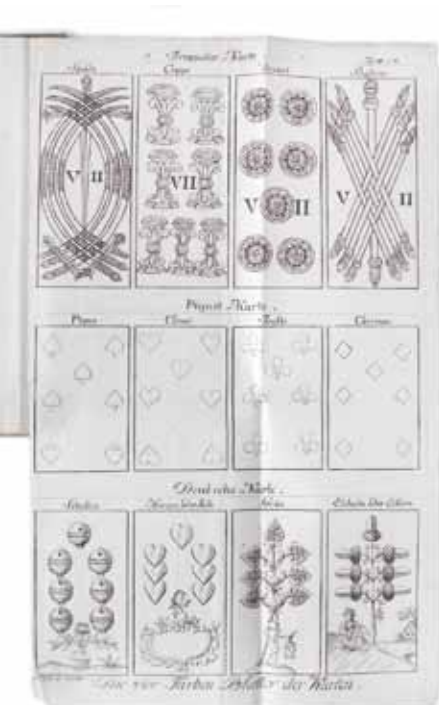

26 From the library of

Johann Gottlieb Immanuel Breitkopf

Vitray, Antoine. *Linguarum orientalium Hebraicae, Rabinicae, Samaritanae, Syriacae, Graecae, Arabicae, Turcicae, Armenicae, alphabeta*. Paris, Antonio Vitray, 1636 (colophon 1635). 4to (187 x 144 mm), pp. [iv], 54, (2) pages with oriental types, woodcut vignette to title; 18th century marbled wrappers in modern half leather binding; front paste-down with printed label of the Librairie Orientale de Dondey-Dupré père et fils; colophon-leaf with mounted woodcut bookplate of Johann Gottl. Imman. Breitkopf "Lipsiae ex Ioh. Gottl. Imman. Breitkopffii Bibliotheca", the famous German printer and publisher.

€ 7500.00

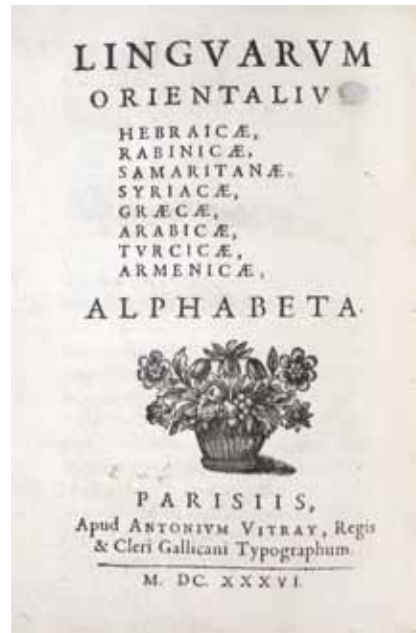

Birrell & Garnett 34 "Extremely scarce". Not in Bigmore & Wyman and in Smitskamp, *Philologia orientalis*. Cf. Updike I, 208-209. First and only edition. Antoine Vitray (ca 1600-1674) became King's printer for Oriental languages in 1622, and in 1635 he succeeded Antoine Estienne as printer to the clergy. He is best known as the printer of the great Paris polyglot of Gui Michel Le Jay, published in ten volumes in 1645. The Oriental types used were partly from the collection of Oriental types formed by Savary de Brèves, French ambassador to Constantinople and Rome. In 1632 after de Brèves death Louis XIII ordered Vitray to buy them and to add Armenian and Ethiopian. Vitray employed Jacques de Sanlecque to cut the punches and strike the matrices for the Armenian type. The types after being used in the famous Paris polyglot were finally handed over to the Imprimerie Royale after Vitray's death in 1674. A few spots, else a fine copy with a distinguished provenance.



27 Unrecorded broadside type specimen by Didot

Didot. Fonderie de Firmin Didot, Rue Jacob, no 24, à Paris, Feuille d’Epreuve no 4. Paris, Firmin Didot, 1818. Full sheet (465 x 610 mm), type specimen arranged in three sections, printed within decorative border; on laid paper, indistinct watermark, some weakening of paper in old folds and short tears repaired on the verso, two small pin holes; margins dust-soiled.

€ 2500.00

Not in Birrell & Garnett, Bigmore & Wyman, or Jammes. A fine broadsheet type specimen from the Firmin Didot typefoundry, to present to printers the new selection of vignettes and fleurons. The type specimen illustrates 71 different borders and vignettes, of which 35 typographic borders, ca 10 individual fleurons, mostly fleurs de lys, 13 composite rules and flower borders, and 14 individual vignettes, showing lyres, urns, satyres etc. The firm of Firmin Didot was founded in around 1775 by François Ambroise Didot, the inventor of the point system. Continued over a number of generations of typefounders, printers and publishers, the firm of Firmin Didot proved immensely influential on French typographic usage, until the mid-nineteenth century when the firm was absorbed in the Fonderie Générale.

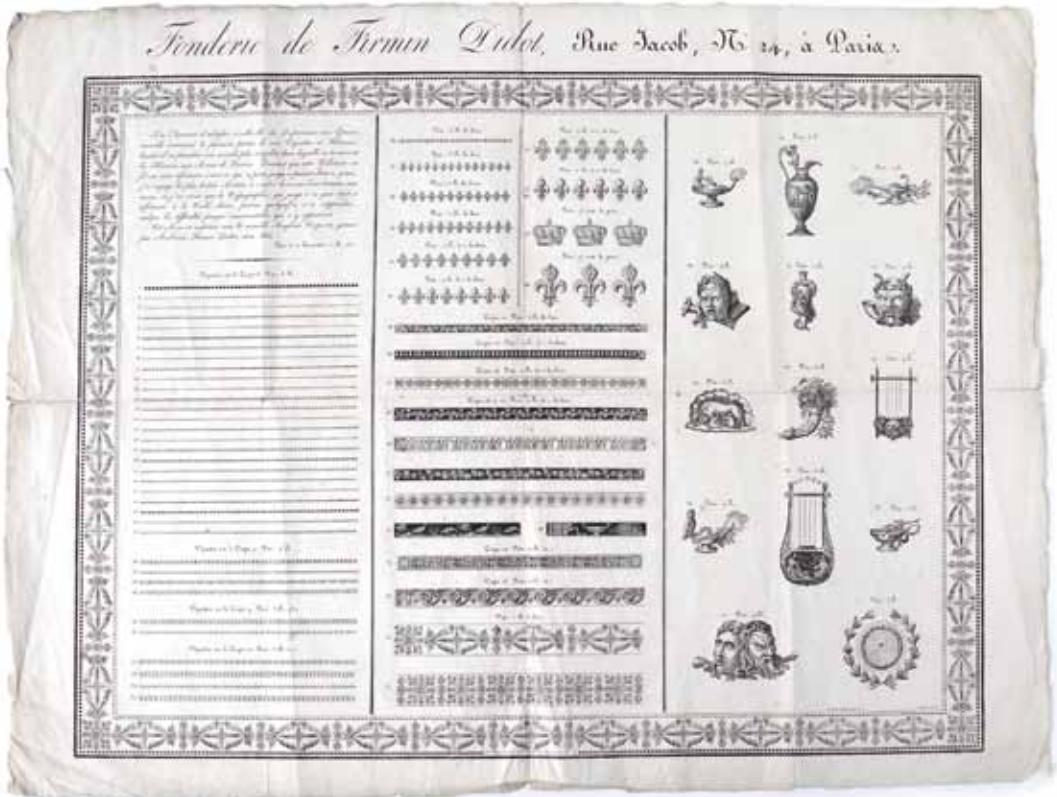



28 'The most important book on French eighteenth century typography'

Fournier, Pierre Simon. *Manuel Typographique, utile aux Gens de Lettres, & à ceux qui exercent les différents parties de l'Art de l'Imprimerie*. Tome I [-II]. Two volumes. Paris, the Author, J. Barbou, 1764/1766 [vere 1768]. Two volumes, 8vo, pp. [iv] two engraved frontispieces, xxxii, 323, [1] errata, [4] privilege, and 8 folding engraved plates; [iv] frontispiece and title, xlv, [ii], 306, and 8 folding engraved plates, pages 177–186 as fold-out pages with printed music; type specimen printed within decorative border; contemporary full calf, spine decoratively gilt, with two gilt-lettered labels and numbering pieces, sides with Greek rule, gilt dentelles, a.e.g.; a little rubbing to joints, front free endpaper removed; a fine copy, with engraved book-plate to front pastedown.

€ 4200.00

Audin, 55,56; Bigmore & Wyman I, 228; Birrell & Garnett 37; Jackson Burke 527; *Printing and the Mind of Man* (Exhibition Catalogue) II, 112; see Updike, *Printing Types*, 1951, I, pp. 250-266 with numerous sample pages. First edition, a fine copy, of Fournier's masterpiece, a magnificent type specimen, which is regarded as 'the most important book on French eighteenth century typography' (Birrell & Garnett 37). His types dominated European printing for fifty years (PMM II, 112). It includes 186 pages of specimens of type and 101 alphabets, ancient and modern, and was 'intended to explain to the layman the intricacies and nuances of the typographic art' (Jackson Burke 527). Fournier's contribution to typography cannot be overestimated. 'His grasp of typography was so complete and so firm that he could venture into every corner of it, its literature, its history, its relation to greater things, writing, architecture, music.' His first contribution had been his 'table des proportions qu'il faut observer entre les caractères', an attempt to standardize type sizes by a point system - a standard which is still in use today. He was a great innovator and moderniser of type faces, and his type specimen gives ample proof of this.



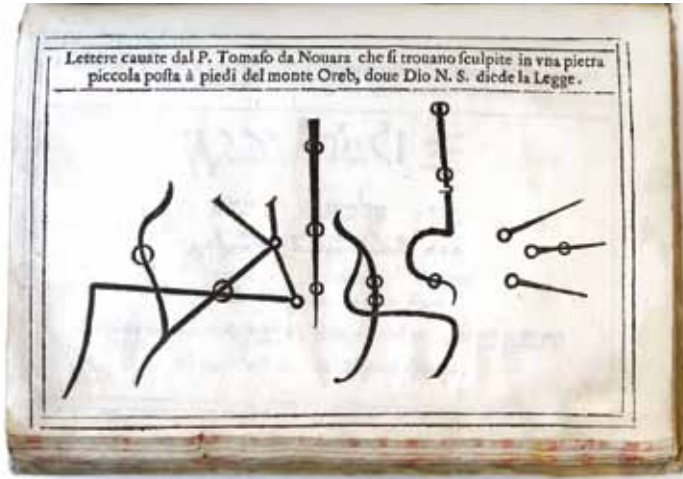

29 Conspectus of type specimens of the Propaganda Fide

[Propaganda Fide:] Thirteen books of alphabets: Armenian, Ge'ez, Arabic, Burmese, Hindustani, Syriac, Estrangelo (ancient Syriac), Coptic, Greek, ancient Etruscan, Georgian; a set of charts of 12 eastern scripts and alphabets; and a Hebrew alphabet; from the press of the Sacred Congregation for the Propagation of the Faith. Rome, 1629-1776. 13 works bound in one volume (details see below); eighteenth-century manuscript list of contents to front free endpaper recto; overall in very good condition (1st title-page has 2 parts of blank cut away and replaced with new paper), some mild browning; eighteenth-century vellum boards.

€ 7500,-

An excellent conspectus of type-specimens from the printing-press of the Sacred Congregation for the Propagation of the Faith, the Catholic missionary organization established in 1622. Present are the press's earliest dated alphabets, in Georgian (1629), Ge'ez (1631), Syriac (1634), and Estrangelo (1636). Most of the alphabets are combined with material in the respective languages, including the Lord's Prayer, the Ave Maria and the Apostle's Creed. This sammelband contains twelve of the sixteen alphabets listed by the director Giovanni Cristofano Amaduzzi (1740-1792) in his 1773 bibliography of the press; as well as a Burmese alphabet from 1776. The twelfth item in the book is particularly unusual. It comprises: „three alphabets of Adam, the first from the Vatican Library, the second by Giacomo Bonaventura, the third by Lorenzo Schrader; four Hebrew alphabets [...] the third by Garamond, and the fourth Rabbinic by Garamond, a character discovered by Tomaso da Novara at the foot of Mt. Horeb; an analysis of the same by Athanasius Kircher; Samaritan and Estrangelo alphabets [...], Chaldaean alphabet [...]“ (Birrell & Garnett).

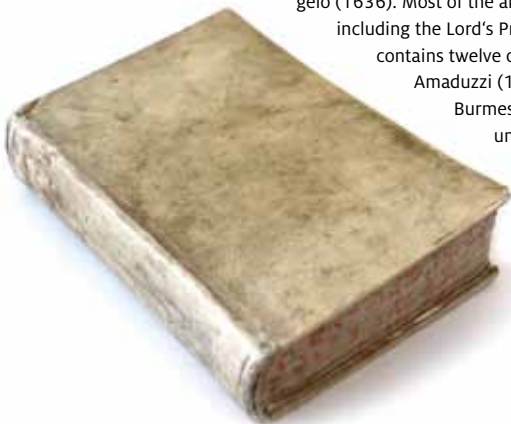



The contents, in total, are:

1. Alphabetum Armenum, iussu S.D.N. Gregorij XV. & Sacrae Congregationis De Propaganda Fide impressum. 1673. Pp. [16] (Amaduzzi p. 7; Birrell & Garnett 10).
2. Alphabetum Aethiopicum, sive Abyssinicum. Cum oratione Dominicali Salutatione Angelica, Symbolo Fidei, & Praeceptis Decalogi, Latina lingua compositis, & Charactere Aethiopico impressis. 1631. Pp. 16 (Amaduzzi p. 7; not in Birrell & Garnett).
3. Alphabetum Arabicum, una cum Oratione Dominicali, Salutatione Angelica, & Simbolo Apostolico. 1715. Pp. 15 [1] (Amaduzzi p. 7; not in Birrell & Garnett).
4. Alphabetum Barmanum seu Bomanum regni Avae finitimarumque regionum. 1776. Pp. XLIV 51 [1] + engraved fold-out. First leaf a blank (Birrell & Garnett 18).
5. Alphabetum Brammhanicum seu Indostanum, universitatis Kasi'. 1771. Pp. XX 152 (Amaduzzi p. 7; Birrell & Garnett 12).
6. Alphabetum Chaldaicum, cum Oratione Dominicali, Salutatione Angelica, & Salutatio ad Virginem Mariam. Latina, & Chaldaica lingua compositis, & impressis. 1634. Pp. [12] (Amaduzzi p. 8; Birrell & Garnett 5).
7. Alphabetum Chaldaicum antiquum Estranghelo dictum, una cum alphabeto syriaco, Oratione Dominicali, Salutatione Angelica, & Symbolo Fidei. 1636. Pp. [16] (Amaduzzi p. 7; Birrell & Garnett 7).
8. Alphabetum Cophtum sive Aegyptiacum. N.d. (c.1670?) Pp. [8] (Amaduzzi p. 8; Birrell & Garnett 9).
9. Alphabetum Graecum, cum Oratione Dominicali, Salutatione Angelica, Symbolo Fidei, & Praeceptis Decalogi. 1771. Pp. 15 [1] (Amaduzzi p. 8; Birrell & Garnett 15).
10. Alphabetum veterum Etruscorum, et nonnulla eorundem monumenta. 1771. Pp. 37 [3] (Amaduzzi p. 8; not in Birrell & Garnett).
11. Alphabetum Ibericum, sive Georgianum, cum Oratione Dominicali, Salutatione Angelica, Symbolo Fidei, Praeceptis Decalogi, Ecclesiae Sacramentis, & operibus Misericordiae. Latine, & Iberica lingua compositis, & Charactere Georgiano impressis: Accesserunt Litaniae B.V. eisdem lingua, & charactibus Ibericis. 1629. Pp. [32] (Amaduzzi p. 8; Birrell & Garnett 3).
12. [P. 1:] Alfabeto del protoparente Adamo I. delineato nella Libreria Vaticana. n.d. [1770?]. Pp. [16] (Amaduzzi p. 7; Birrell & Garnett 4).
13. Alphabetum Hebraicum, addito Samaritano et Rabbinico, cum Oratione Dominicali, Salutatione Angelica, & Symbolo Apostolico. 1771. Pp. 16 [12] (Amaduzzi p. 8; Birrell & Garnett 14).



30 Exotic characters

Goupy, Victor. *Spécimen des Caractères étrangers*. Paris, Victor Goupy, [n.d., ca 1860s]. Oblong 8vo, pp. [iv], with ll. 32 [vere 36 8a-d], all printed within a green decorative border; original printed wrappers, spine strengthened, a little dog-eared, else fine.

€ 600.00

Not in Bigmore & Wyman, not in Jammes; Bibliotheque Paris-Bulac lists just ll. 28; see Bigmore & Wyman I, 274 for Goupy's 1874 publication. An interesting type specimen of exotic characters, including Greek, Hebrew, Polish, Armenien, Ethiopien, Arabic, Coptic, Sanscrit, Manchurian, Tamil, Mongolian, Syriac, Tibetan, Samaritan, Iranian, Japanese, Chinese, Tuareg, Cuneiforme and hieroglyphics. The longer texts are the beginning of the Lord's Prayer, otherwise the different fonts are given in various sizes and on a number of different bodies. Victor Goupy later wrote on the collection of oriental types at the Imprimerie Nationale (1874).

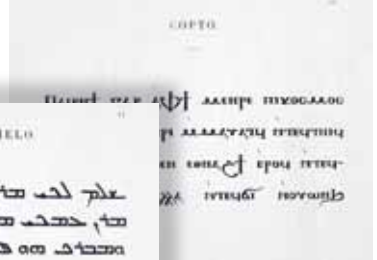
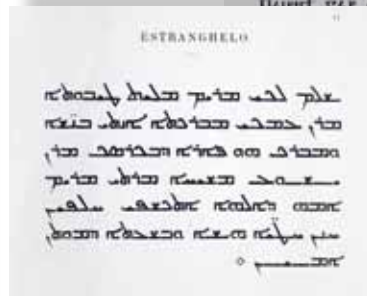

31 Oriental type

Tipografia Orientale. *Saggi di Caratteri della Tipografia Orientale del R. Istituto di Studi Superiori*. [pubblicati in occasione del quarto Congresso Internazionale degli Orientalisti in Firenze.] Florence, Tipografia dei Succs. Le Monnier, 1887. Oblong 4to (192 x 275mm), pp. 31; printed on recto only; original printed wrappers; a little dog-eared and dust-soiled, spine covering worn; some spotting to wrappers, but clean internally.

€ 900.00

Not in Bigmore & Wyman, OCLC lists copies at the Bibliothèque Nationale and Erfurt only. First and only edition of this type specimen published on the occasion of the IV international Orientalist congress in Florence in September 1887. Included are a variety of characters, both Arab and Hebrew, including Syriac, Coptic, Sanscrit, Rabbinic type, Chinese and Japanese.

32 Rare French type specimen

V(euv)e Lacroix & Boucault. Spécimen des caractères de la fonderie de Ve Lacroix & Boucault, son neveu. Premier cahier (= all published). Paris, P. Baudouin 1837. 8vo, ll. 2 (title and advertisement), ll. [64] and 2 folding leaves, printed on rectos only; publisher's printed wrappers; spine-ends slightly damaged.

€ 2750.00

Cf. Audin p. 43. First and only edition. According to Audin the type-foundry was active between 1837-1840. Folding leaf with traces of worming in folds. A nice copy of this scarce type specimen. No copy found in any library worldwide on KVK.

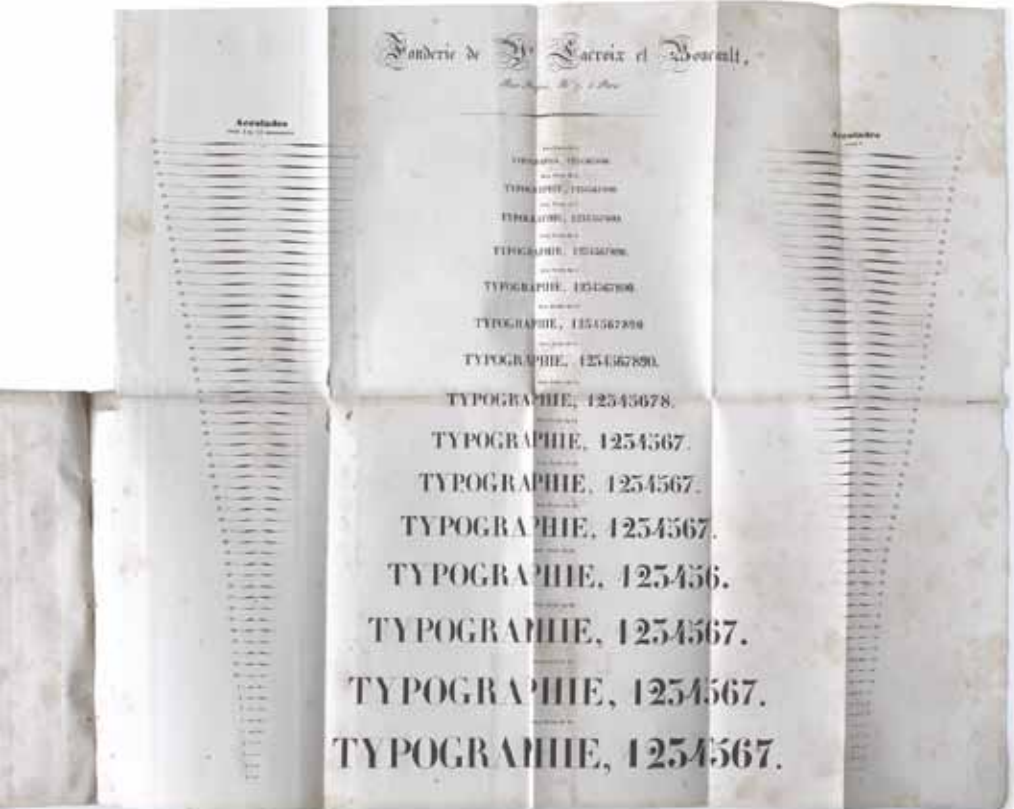



33 English writing master

Champion, Joseph. New and complete alphabets in all the various hands of Great Britain, with the Greek, Hebrew, and German characters. London, Robert Sayer, ca. 1760. Oblong 4to, (165 x 225

mm); ll. 21 engraved on one side only; paper a little browned and dust-soiled; title with repair to verso, possibly resulting from the removal of a book-plate; recent calf-backed boards, with original label mounted to upper board.

€ 720.00

ESTC t149007; see Heal, p. 181; Becker 213; Bonacini 349-50, Berlin 5067, all apparently other editions. An attractive copy book by the writing master and accountant Joseph Champion (1709 -1768), who published a number of works on calligraphy. In addition to English and Italian capitals, a secretary alphabet, an italic script alphabet, a number of court alphabets, a chancery alphabet, and Greek and Hebrew alphabets are included. There appear to be a number of issues/editions of this work, the original c. 1754 engraved by Bickham (watermark crowned shield with fleur-de-lis over LVG), another undated edition engraved by John Howard, printed on the same paper (this one), and a 1790s edition on wove paper. The present copy is dedicated to the Princess of Wales.



34 Demonstrating the economical and ethical foundations of the publishing trade

Perthes, Friedrich Christoph. Der deutsche Buchhandel als Bedingung des Daseyns einer deutschen Literatur. (Hamburg, Perthes) 1816, im July. 8vo, pp. 35, (1), sewn as issued, spine covered with marbled paper strip, title and last leaf slightly dust-soiled, last leaf with two tiny rust holes in white margin.

€ 900.00

Lexikon des Gesamten Buchwesens V, 601. ADB XXV, 394-399. First edition. Perthes (1772-1843) was among the most important 19th century German publishers. "Von seinen programmatischen Schriften ist die wichtigste und heute noch maßgebliche 'Der deutsche Buchhandel'. Sie zeigt prägnant die ethischen und wirtschaftlichen Grundlagen des Buchhandels" (LGB V, 601).



35 Calligraphy and typography – a sample book

Calligraphy. Calligraphy and Typography Sample book, including Heinrigs, Jean. *Le Maître d'écriture des Commerçans en Caractère Français, Anglais, Hollandais, Italien et Alleman. Der kaufmännische Schreibmeister*. Krefeld, Heinriggs, 1813. [n.p.] ca 1820. Folio, (400 x 255 mm), ll. 50, first 20 ll., Heinriggs' calligraphy manual, the remainder examples of engraved calligraphy, cut out and pasted on, partly in the form of model title pages (31), printed alphabets and sample book title pages (13), 2 manuscript calligraphy samples in ink, 40 business- and calling cards in German, English, and French and employing a number of techniques (engraved, stencil, embossed, porcelain finish), 17 finely engraved ciphers with names micro-engraved within them, examples of assignats, advertising material, sample invoices, circular letters, and bankdrafts, etc; contemporary half calf over blue boards, lozenge-shaped title label to upper board. Spine and corners quite worn, head and tails chipped, but holding; occasionally a little spotted and with some light damp-staining, but overall in very good condition.

€ 2500.00

A fascinating source-book of late eighteenth and early nineteenth century lettering, calligraphy, calling card design, and book- and title page lay-out possibly prepared as a sample book for a local jobbing printer, illustrating a wide variety of designs. The most likely origin of the album is the Rhineland, but numerous French and English examples are included as well.



36 Secrets & recipes, including paper-marbling and book-binding

Smith, Godfrey. *The Laboratory or School of Arts: in which are faithfully exhibited and fully explain'd, I. A variety of curious and valuable experiments in refining, calcining, melting, assaying, casting, alaying, and toughening of gold; with several other curiosities relating to gold and silver; ... Second Edition. To which is added, An Appendix: Teaching, I. The Art and Management of Dying Silks, Worsteds, Cottons, & c in various Colours. II. The Art of preparing Rockets, Crackers, Fire-globes, Stars, Sparks, & Recreative Fire-works. Illustrated with copper plates. Two parts in one volume. London, J. Hodges, J. James and T. Cooper, 1740. 8vo, engraved frontispiece, pp. [viii], 240 with 5 engraved plates; [ii], lxxx, [6] index, [2] blank, with three engraved plates (two of which folding), dampstain to gutter margin of last two leaves; ownership inscription partly removed from title page and at head of preface; ink inscription with dyeing recipes in ink pasted on front free endpaper; contemporary calf, rubbed and bent; lacking spine label.*

€ 1250.00



ESTC t 65470; C. Philip, Bibliography of firework books, S160.5. Second edition, much enlarged, of Godfrey Smith's compendium of secrets and recipes first published in 1738. Smith here includes the earliest descriptions and illustrations of paper marbling (p. 142 ff), and gives a thorough introduction to book-binding (see Pollard & Potter, *Early bookbinding manuals*, no 73, and Richard Wolfe, *Marbled paper*, p. 64-65, illustrating the plate). This is the true second edition, reset, rather than a re-issue of the first with a cancel title-page. It contains a new section on cosmetics (Part XII), the Appendix is a re-issue, with the date changed to Roman numerals and the price removed.



37 The beginning of colour printing

Le Blon, Jacques-Christophe. *L'Art d'imprimer les Tableaux. Traité d'après les Ecrits, les Opérations & les Instructions verbales.* Paris, P.G. Mercier, Jean-Luc Nyon, & Michel Lambert, 1756. 8vo, pp. xi, [1] blank; vi, [2], [xiii] - xxv, [26]-180, with one hand-coloured sepia mezzotint (possibly very slightly shaved at foremargin) and two black and white folding plates, bound without the final *Privilege du Roy*, which was clearly never present in this copy; contemporary full calf, flat spine in compartments, with gilt-lettered spine label; joints a little rubbed and corners bumped, a good copy.

€ 8200.00



Bigmore & Wyman I, 67; Franklin, *Early Colour Printing*, p. 40; J.M. Friedman, *Color Printing in England 1486-1870*, 13. Second edition of Le Blon's landmark introduction to the three colour process of printing mezzotints, based on Newton's colour theory and generally regarded as the foundation of modern colour printing - and the first edition to include practical information on the printing process. Le Blon's process consisted of printing three mezzotint plates, each in one of the primary colours of red, blue and yellow, on the same sheet of paper, thereby reproducing all the compound colours visible in an original picture. ... Le Blon made his first colour prints after his own designs in Amsterdam, c. 1704. In 1715, hoping to be granted a royal privilege of monopoly for his process, he visited The Hague and Paris, and eventually settled in England. It was during this time, that he published details of his process in the virtually unobtainable *Coloritto*, or the *Harmony of Colours in Painting*, (1723), which explained the theory but not the practice of his process. *Coloritto*, with text both in English and French, is incorporated in this book, which was published after Le Blon's death by A. Gautier de Montdorge, one of his French followers.

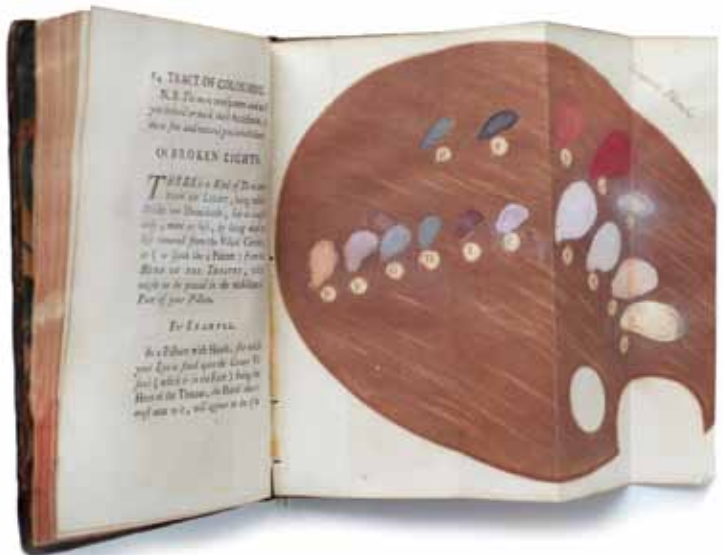

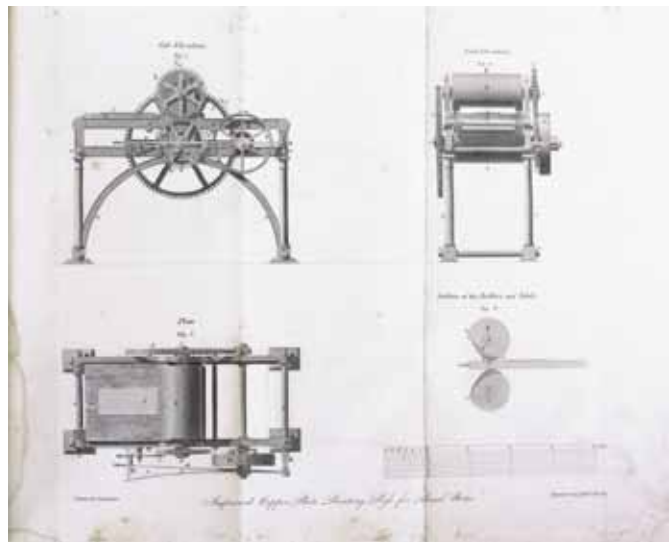
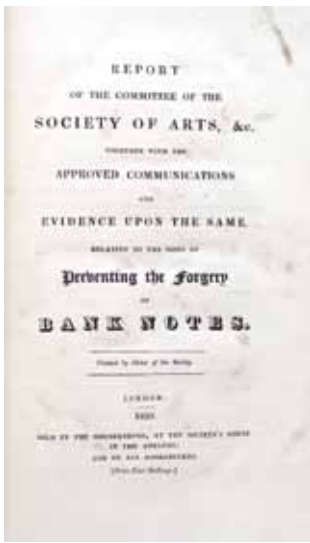

38 Security engraving to prevent forgery of bank notes

Forgery. Report of the Committee of the Society of Arts, &c. together with the approved communications and evidence upon the same relative to the mode of preventing the forgery of bank notes. Printed by order of the society. London, T.C. Hansard, 1819. 8vo, pp. [iv], 72 [i.e. 76], with 6 engraved plates, one folding, large paper copy; uncut in original boards, rebacked, a fine copy.

€ 1750.00

Goldsmiths'-Kress 22503. First edition, uncommon, of a proposal for the introduction of a number of different printing processes designed to prevent the forgery of bank notes. Suggestions include Hansard's typographic bank note, machine engraved copper-plates, engine turned ornaments, delicate steel-engravings. The report is well illustrated with plates showing examples of the suggested printing process. The two plates illustrating steel-engraving, are some of the earliest successful examples of the technique which was to dominate book illustration between 1835 and 45. Early bank-notes were simply printed forms, in which the amounts were written by hand. They were usually for large amounts (£40 and upwards) and were printed upon water-marked paper; and, although no precautions were taken in the engraving to prevent fraudulent imitation, forgeries were comparatively rare. But, when at the end of the 18th century small notes for £1 and £2 were put in circulation, forgery became rife, and from that time to the present a constant trial of skill has been going on between the makers of bank-notes and the counterfeiters.





39 The first book to be successfully printed with the crayon method of colour printing

Fossé, Charles-Louis. *Idées d'un Militaire pour la Disposition des Troupes confiées aux jeunes officiers dans la Défense et l'attaque des Petits Postes*. Paris, Franc, Amb. Didot l'aîné, 1783. 4to, pp. [xiv], 116, 60, with 11 colour printed plates (ten of which folding) each with a leaf of letterpress printed explanation, and pp. [2] privilege; with arms of the dedicatee, the Duc du Chatelet also printed in colour; all plates signed Bonnet ,premier graveur de ce genre', and bound in sideways for ease of use, rather than at head; contemporary full mottled calf, flat spine with red roan overlay, ruled and lettered in gilt; extremities a little worn; a good copy.

€ 4000.00

Benezet II, p. 5; Brunet II 1354; Graesse II 620; NBG XVII, c 247-8; Thieme-Becker IV, 311; Waddleton, *Books with colour printed illustrations*, 1783.2. First edition of the first book to be successfully printed with colour-plates, following the crayon method. Louis-Marin Bonnet (1736–1793) imitated the effect of multi-colour drawings by using several crayon-manner plates, each inked with a different colour; this is the only book illustrated by him using this method. In the first part Fossé (1734–1812), a French infantry officer and mathematician, discusses questions of tactics, the second part, however, is concerned with the best methods of producing coloured military maps and charts. The attractive plates are drawn by Fossé, and engraved by Bonnet.





40 Strickland, Agnes. *The little Tradesman, or, A peep into English Industry*. Accompanied with forty-eight copper-plates (vere 24 copperplates). London, William Darton, [1824]. pp. 91, [1] advertisement, with 24 illustrations on twelve engraved plates, one bound as a frontispiece; contemporary red roan-backed marbled boards, corners a little rounded.

€ 540.00

Osborne Coll., I, 187 & 212./ Date from date on plates: 9mo. 2nd. 1824./ Publisher's ads, [1] p. at end. A fine introduction to trades and professions for children by the prolific children's author Agnes Strickland (1796-1874). The charming plates show a great variety of tradesmen and artisans in their workshop surroundings. The accompanying text gives extensive factual information on the professions and their use and role in society, followed by a brief poem.



41 The tercentenary of printing – Gutenberg celebrated

Leich, Johan Heinrich. *Gepriesenes Andencken von Erfindung der Buchdruckerey wie solches in Leipzig bey dem Schluß des dritten Jahrhunderts von den gesammten Buchdruckern daselbst gefeyert worden*. Leipzig, 1740. 4to, pp. lvi, 88, 81-102, [3] - 176; with engraved title vignette, two further engraved vignettes, showing the interior of a printing office, portraits of Gutenberg and Fust etc.; numerous decorative initials and head- and tail -pieces; very clean and crisp in contemporary vellum.

€ 780.00



Bigmore & Wyman I, 8. First and only edition of this full account of the public proceedings at Leipzig to celebrate the third centenary of the invention of printing. Included are a listing of all printers, an assessment of the importance of the invention of printing, a celebration of Gutenberg, orations by Fred. Menzius and Ernesti in Latin, Gottsched's and Mayer's eulogies in German, and number of celebratory poems, one of them in Hebrew.



42 Trades & professions illustrated, including printers, engravers and book-binders

Luyken, Jan and Caspar. Spiegel van het Menselyk Bedryf, vertoonende honderd verscheiden ambachten, konstig afgebeeld, en met godlyke spreuken en stichtelyke verzen verrykt. Amsterdam, Jan Roman de Jonge, 1749. 8vo, pp. [viii] including engraved title, 208, [3] index and advertisement, with one hundred engraved plates of trades; contemporary full vellum, blindstamped with central device to upper and lower board; spine lettered in ink; a fine crisp copy.

€ 2500.00

Landwehr, Emblem and Fable books printed in the Low Countries 1542-1813, 3rd edition 536; van Eeghen 244, pp. 262. Later edition of Jan and Caspar Luyken's book of trades (first 1694), presenting in one hundred plates all trades and professions practised in the Netherlands at the end of the seventeenth century. This was one of the most popular children's books of the eighteenth century, and served not just as a depiction of how things were made, but also as a guide to professions to take up. The work gives a fascinating overview of the professions active in the Netherlands and elsewhere in Northern Europe at the time. In each case the professional is shown in his typical working environment surrounded by tools, customers, and equipment.



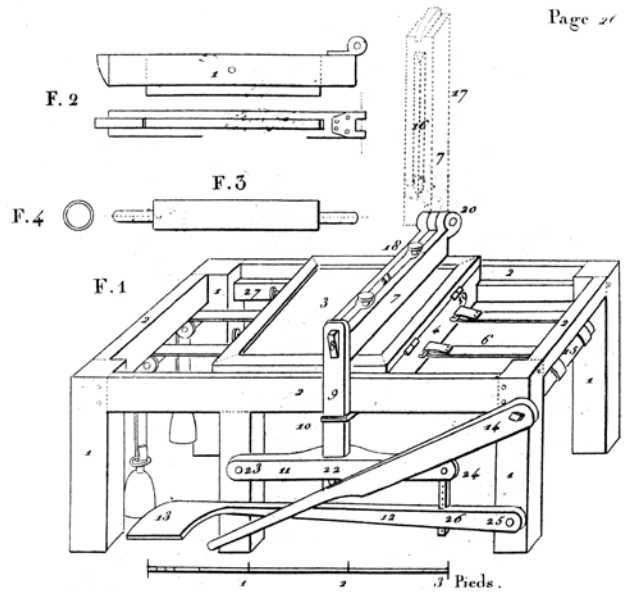
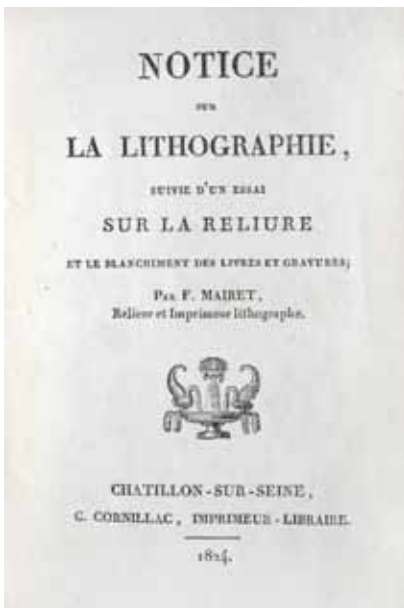

43 Lithography and bookbinding

Mairet, F(rancois-Ambroise). Notice sur la lithographie, deuxième édition suivie d'un essai sur la reliure et le blanchiment des livres et gravures; ... Chatillon-Sur-Seine, C. Cornillac 1824. 8vo, pp. 228, four lithograph plates, one engraved plate; contemporary half leather, gilt label to spine; repair to foot of spine.

€ 2000.00

Bigmore & Wyman II, 14. Mejer I, 1927. Pollard and Potter, Bookbinding manuals 52. Twyman, Lithography 1800-1850 pp. 92-95. Second edition. First with the second part (beginning on p. 69) which deals exclusively with the art of bookbinding. The author names himself on the title "Relieur et imprimeur". The lithographed plates with landscapes in various techniques, the engraved plate with a lithographic press. A nice uncut copy with only marginal spotting to a few pages.





44 One of the most important French printing manuals
 Momoro, Antoine François. *Traité élémentaire de l'Imprimerie, ou Le Manuel de l'Imprimeur*; avec 36 planches en taille-douce. Paris, Veuve Tiliard & Son, 1796. 8vo, pp. [iv] (cancel title), 347, [1] errata, with 36 engraved plates (numbered 1-28, and 1, 2, 13-18) and 1 folding engraved table bound in; some light browning of the paper; contemporary full calf, flat spine gilt, gilt-lettered spine label; repairs to joints and head and tail of spine; overall a good copy.

€ 3300.00

Bigmore & Wyman, II, 48; Gaskell, Barber & Warrilow, F6; Jackson Burke 984. Re-issue of the first edition with a cancel title page of, one of the most important French [printing] manuals. A brief introduction covers the history of printing, the different types, and parts of the press, as well as the principal operations of printing. The rest of the work consists of articles, in alphabetical order, dealing with every aspect of printing and the printing world and often giving detailed descriptions of contemporary practice. An alphabetical list of the headings used follows together with specimen impositions, case layouts, and engraved proof-correction sheet and nine other plates' (Gaskell, Barber & Warrilow, F6). The other plates show views of the printing office, illustrating type-setting, paper-making and printing, and also show a number of different printing presses with close-ups of individual parts and tools.

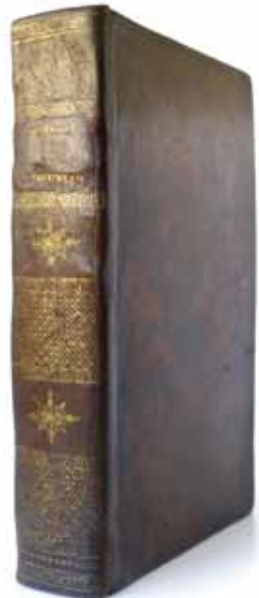



45 Early Austrian lithography

Gaheis, Franz de Paula. Buergerfeyer am 30. October 1804, bey der Einsetzung des Wohlgebornen Herrn Stephan Edlen von Wohlleben ... in die Wuerde eines Buergermeisters der K.K. Haupt- und Residenz-Stadt Wien, dann Ernennung desselben zum Obersten des loeblichen Wiener Buerger-Regiments. Herausgegeben zum Besten der armen Buerger in der Versorgungs-Anstalt zu St. Marks. Wien, Joseph Hraschanky for Franz Joseph Roetzl 1804. Two parts in one volume. Folio, pp. 55, with three engraved vignettes, 2 aquatint portraits, – and: Cantate im Klavierauszuge, welche den 5ten November 1804 bey Gelegenheit des Bürgermeister-Festes ... abgesungen wurde. Die Worte sind von Herrn Franz Gaheis magistratischem Secretair, in Musick (!) gesetzt von Herrn Kapellmeister Preindl. Wien, gestochen in der K. K. priv. chemischen Druckerey (1804). Folio, pp. 15 lithograph pages with music including lithograph title with floral border by J. N. F. A. Senefelder. Publisher's brown silk binding, oval typographical label mounted to front board; binding slightly soiled.

€ 1600.00

Holzmann-Bohatta I, 8408a. Bibliotheca Viennensis 2080. Goedeke VI, 547,33. First and only edition. Contains an early and important Austrian incunabula of lithography from the lithographic press founded by Senefelder in Vienna. "Diese 8 Blätter umfassende Notenbeilage ist nach der Bezeichnung eine in der Chemischen Durckerei 'gestochene', eigentlich aber chemisch gedruckte Cantate im Klavierauszug von Preindl und Gaheis; ihr Titelblatt weist eine der ersten in Wien entstandenen lithographischen Verzierungen auf und ist deshalb bemerkenswert, auch wenn diese Darstellung, ein Blumenkranz mit einer Umrahmung des unteren Schriftrandes, noch recht derb und unbeholfen mit der Feder gezeichnet ist" (Schwarz, Anfänge der Lithographie in Österreich p. 178). A fine copy.



Tropfen aus 2. u. 3. u.

Das Reiter-Lied.

Leutg.
Festgung.

Halt auf! Du siehst das Feindes-Heer auf's Pferd und stehst an der Front! Du siehst
 die Feindes-Heer auf's Pferd und stehst an der Front! Du siehst die Feindes-Heer auf's Pferd
 und stehst an der Front! Du siehst die Feindes-Heer auf's Pferd und stehst an der Front!

Chor.
 Hier ist die Feindes-Heer auf's Pferd und stehst an der Front! Du siehst die Feindes-Heer auf's Pferd
 und stehst an der Front! Du siehst die Feindes-Heer auf's Pferd und stehst an der Front!

Umarmung!
 Es ist die Feindes-Heer auf's Pferd und stehst an der Front! Du siehst die Feindes-Heer auf's Pferd
 und stehst an der Front! Du siehst die Feindes-Heer auf's Pferd und stehst an der Front!

L. v. Schiller 1807

46 Early German incunable of lithography printed in only 150 copies

Schiller, (Friedrich von). Reiterlied von Schiller. SteinDruck. Stuttgart in der Stein-druckerey und Tübingen in der J. G. Cotta'schen Buchhandlung. J. Carl Ausfeld 1807. Large folio, ll. [5], lithographed throughout in 3 different techniques, one frontispiece (chalk drawing), title-page (verso blank) and pp. 4 of text (engraving on stone), pp. 2 music (pen drawing), all signed and dated 1807; publisher's green wrappers; some minor dust-soiling and browning to covers, corners dog-eared, spine damaged.

€ 8000.00

Fischer, Cotta-Verlagsbibliographie 676. Winkler 029 (for Ausfeld) and 703 (for Seele). Cat. Von Se-nefelder zu Daumier 129. Slg. Aufseesser 536 (with illustration) "Von grösster Seltenheit." First and only edition, printed in only 150 copies. "Erst im Januar 1808 fertiggestellt und ausgegeben. ... Nach der Anzeige im Morgenblatt für gebildete Stände 1808, Nr. 9 bildet das Werk ein Musterstück des von Rapp und Cotta betriebenen Stuttgarter Steindruck-Instituts für verschiedene lithographische Techniken: Feder- und Kreidelithographie sowie Steingravur" (Fischer I, S. 757). This publication was intended by Rapp as a showcase specimen book for various lithographic techniques. The lithography was done by Rapp himself. After only 3 years (1807-1810) the lithographic office was sold.

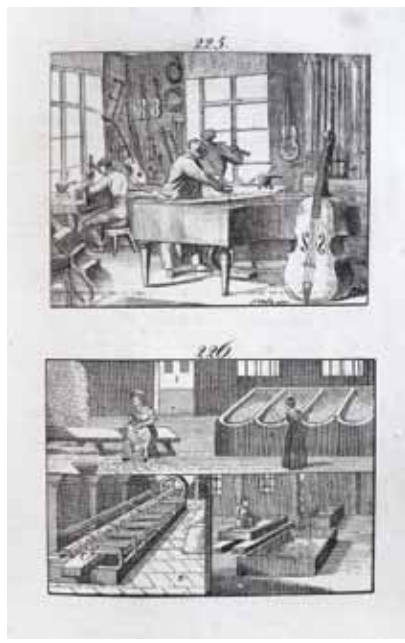

47 With fine lithograph illustrations of printer, engraver, typesetter & paper-maker etc.

Comenius - Gailer, J.E. *Neuer Orbis Pictus für die Jugend, oder Schauplatz der Natur, der Kunst und des Menschenlebens* in 322 lithographirten Abbildungen mit genauer Erklärung in deutscher, lateinischer, französischer und englischer Sprach nach der früheren Anlage des Comenius bearbeitet und dem jetzigen Zeitbedürfnisse gemäss eingerichtet. Reutlingen, Johann Conrad Mäcken, 1835. 8vo, frontispiece, pp. x, 706, [3] index, [1] imprint, and 320 lithograph illustrations on 160 plates illustrating professions, etc., [1] final lithograph; contemporary half roan over marbled boards, flat spine gilt, red gilt-lettered spine label; label with central crease, but an unusually attractive copy.

€ 1500.00

Pilz, *Die Ausgaben des Orbis Sensualium Pictus*, pp. 363-66. Third Gailer edition (the first published in 1832) and the first to include English of this nineteenth century re-working of Comenius' *Orbis Pictus*. In his interesting preface Gailer mentions that the religious content has been toned down, and that he has attempted to include information on recent scientific discoveries, such as electricity and the air pump. The work includes a number of depictions of papermakers, printers, & booksellers.



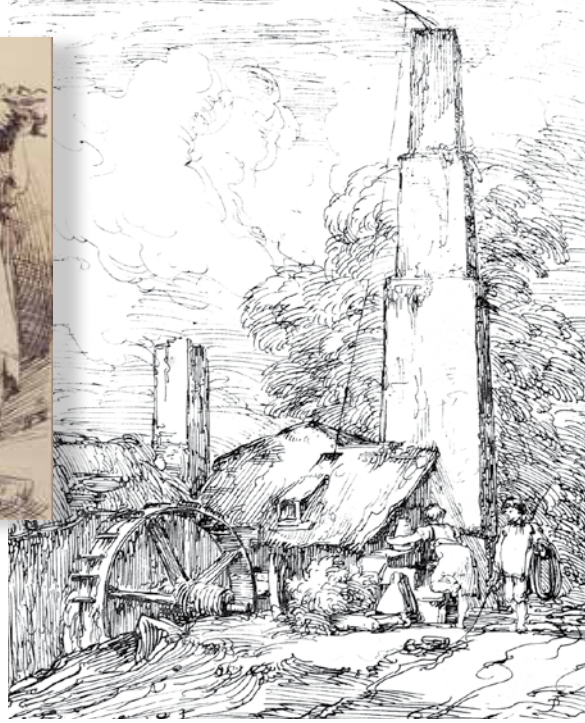

48 First collection of landscape lithography published in England

Barker, Thomas. Forty lithographic impressions from drawings by Thomas Barker, selected from rustic figures after nature. Published by subscription at Bath. December 1813. Folio, ll. [3], letterpress text (title, 'advertisement' and 'subscriber's list'), 40 lithograph plates on tinted paper mounted on board.

[bound with:]

Barker, Thomas. Thirty two lithographic impressions from pen drawings of landscape scenery. Only fifty copies printed. Printed under the direction of Mr. Barker by D. Redman. Bath, 1814. Folio. lithograph title, ll. 2 letterpress text ('advertisement' und 'index'), 32 lithograph plates mounted on board; contemporary green half calf, spine lettered in gilt, mounted gilt leather label to front cover; front fly leaf with binder's stamp of "David Chivers, Bath, Greenstreet 20"; spine renewed with original spine laid down; inner hinges strengthened.

€ 6500.00

Ad I. Twyman 182; not in Abbey, Life in England, Aufseesser collection and Grolier Club (ed.), Catalogue of a centenary of artistic lithography 1796-1896. One of two hundred copies. Minor brown spots to margins else fine. "This is the most substantial English album of lithographic incunables" (Ray, England 80).

Ad II. Twyman, 181/182. Not in Abbey, Life in England, Aufseesser collection and Grolier Club (ed.), Catalogue of a centenary of artistic lithography 1796-1896. One of only 50 copies. "One early example from the incunabula of lithography in the pen and ink style deserves mention ... since it was the first important collection of landscape lithography to be published in England. ... At the time Bath possessed what was probably the only lithographic press in England which catered for the printing of artists' drawings ... " (Twyman p. 181 and 182). Boards heavily browned due to glue, plates not affected. With one variant of plate XI loosely laid in mounted on new cardboard. From the Winkler collection with his small stamp on verso of plate VI. A nice sammelband with two early English incunables of lithography.





49 Colour printing and art

Ploos van Amstel, Cornelis. A sammelband with 35 mounted plates in various techniques. (Amsterdam, around 1770).

- I. Cornelis Ploos van Amstel. Folio (425 x 385 mm), 18 plates, of which 9 printed in colours (dated between 1763 and 1769).
- II. Cornelis van Noorde. 10 plates of which 2 printed in colours (dated between 1765 and 1769).
- III. Johannes Jacobus Bylaert. 4 plates (dated between 1768 and 1770).
- IV. William Baillie. 3 watercolour paintings (dated 1758 and 1761). All plates mounted on heavy paper with grey watercolour borders. - and: Enschede, Johann. Aan de Beminnaars der Teken- en Schilder-Konst (drop-title). Harlem, 24. Juny 1769. Pp. 4 text. Contemporary calf, gilt spine, covers gilt, all edges gilt, marbled endpapers, spine and corners renewed.

€ 18000.00

I. Laurentius, Th.; J. W. Niemeijer und G. Ploos van Amstel: Cornelis Ploos van Amstel 1726-1798 Kunstverzamelaar en prentuitgever. Assen, 1980. For Ploos van Amstel (1726-1798). With all 18 prints made by himself in his newly developed techniques. Each print with his stamp on back and handwritten annotations. "It is clear from all this that after 1770 Ploos confined himself to initiating and organizing the work and made no more prints himself. ... In the first five years of the undertaking more coloured prints were published than black and white, but after 1770 interest in them flagged and the last was published 1775. ... We know from Ploos' own records that 350 impressions were made of each print. ... many of which were gifts or presentation copies, the latter always bearing inscriptions in his own hand on the back" (Warde in C. Ploos van Amstel pp. 323-333-334 and Laurentius, Catalogus der Hoofdprenten No- 1-18).



II. Thieme-B. XXV, S. 509. For Cornelis van Noorde (1731-1795). With the famous engraving of Jan van Eyck's "Die heilige Barbara" with pen and ink frame and cont. handwritten caption "Joh. Enschede, Harlemensis, Possessor hujus picturae originalis, excudit 1769. Corn. van Noorde, Harlemensis sculpsit ex originali 1769". This print goes together with the letterpress item by Enschede.

III. Johannes Jacobus Bylaert (1734-1809). "Er erfand eine Crayon-Manier, die von der von Ploos van Amstel und von Cootwyk verschieden ist und über die er 1772 in Leiden ein Buch publizierte" (Thieme-B. V, 314). All prints by van Noorde and Bylaert with manuscript captions on back naming artist, subject and date of the print.

IV. William Baillie (1723-192), Art dealer and artist amateur "Von 1760-1779 fertigte er Jahr für Jahr einige Werke in Ätz-, Kreide-, Tusch-, Schab- und Farbenmanier ..." (Thieme-B. II, 369). An interesting compilation of prints in the most advanced graphique techniques, partly invented or improved by the artists themselves for reproducing paintings as similar to the original as possible.



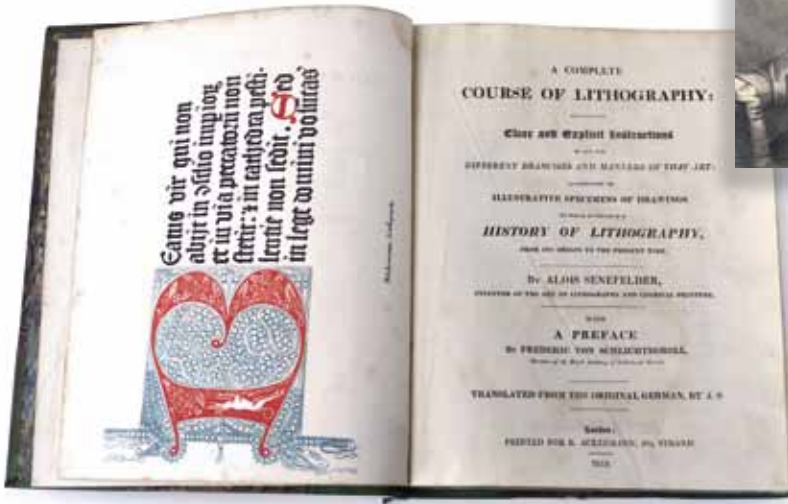

50 First English edition

Senefelder, Alois. A complete course of lithography: Containing clear and explicit instructions in all the different branches and manners of that art: Accompanied by illustrative specimens of drawings. To which is prefixed a history of lithography, from its origin to the present time. With a preface by Frederic von Schlichtegroll. Translated from the German, by A. S. London, Ackermann, 1819. 4to, pp. xxviii, (4), 342 (recte 340), (2) and 14 lithographed plates (of which one folding), a few woodcut text-illustrations; contemporary half calf, two gilt red morocco labels, richly gilt spine, gilt borders on sides, marbled endpapers and marbled edges. Binder's ticket of „James Condie, Paisley“ on front pastedown, edges very lightly rubbed.

€ 3000.00

First English edition. "It contains a history of the art from 1796 to 1817 – two years before the publication of the work. The rest of the work is devoted to an elucidation of the practical working and applications of lithography, and is illustrated by 14 plates in the various styles, including a portrait of Senefelder" (Bigmore & Wyman II, 340). A few insignificant brown spots especially to margins of plates. Clean and fine, a broad-margined copy, printed on thick paper.

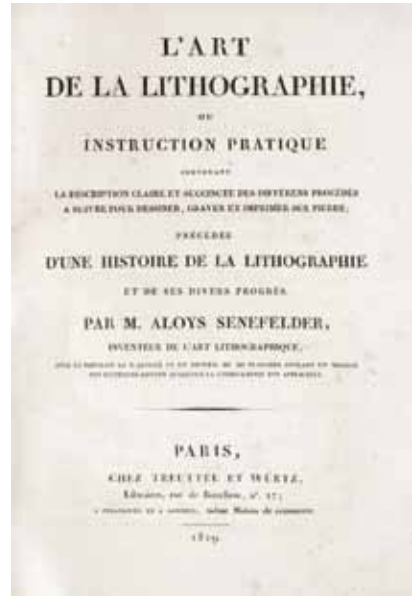

51 First French edition

Senefelder, Aloys. *L'art de la lithographie, ou instruction pratique* contenant la description claire et succincte des différens procédés à suivre pour dessiner, graver et imprimer sur pierre; précédée d'une histoire de la lithographie et de ses divers progrès. Text and atlas in one volume. Paris, Treuttel et Würtz 1819. 40, lithograph frontispiece portrait of Senefelder, pp. [vi], 262, with 20 plates in various lithographic techniques; purple half morocco around 1860, gilt title to spine.

€ 8000.00

First French edition with variant plates in comparison to the German edition. Slight marginal spotting to a few leaves. A broad-margined and bright copy.





52 Printing and publishing on an industrial scale

Mame, Alfred. Notice et spécimens. Tours, Alfred Mame 1867. Folio (400 x 280 mm), pp. [iv] 18, 7 woodcut plates (of which one double-page), 57 leaves with sample pages of their publications; including full-page illustrations in various techniques, mounted specimens, gilt and silver printing; publisher's red pebble-grain cloth, spine gilt, front cover with gilt title; covers rubbed and soiled. € 600.00

Bigmore & Wyman II, 16. First edition of this documentation of the innovative printing works of Alfred Mame, who was the first to unite under one roof all industries relevant to producing books. In the first part the various buildings of the establishment are illustrated, giving inside views of the composition room, press room, printed paper storeroom, binding room and showroom together with a double-page view of the huge factory grounds. The second part shows sample pages of their publications.



53 Maurer & Dimmick. Denkschrift der werthen Kundschaft, (...) gewidmet aus Anlaß des fünfundzwanzigjährigen Bestehens unserer Firma Maurer & Dimmick Buch- und Kunstdruckerei, Verlag, Rotationsdruck Stereotypie, Buchbinderei 1889-1914. (Berlin, Selbstverlag 1914). 4to (340 x 240 mm), ll. 12 with 12 plates of portraits of the company owners and the various print rooms, mounted on board, text and plates within Art nouveau borders; colour illustrated wrappers, uncut. € 380.00

A fine company commemorative publication.



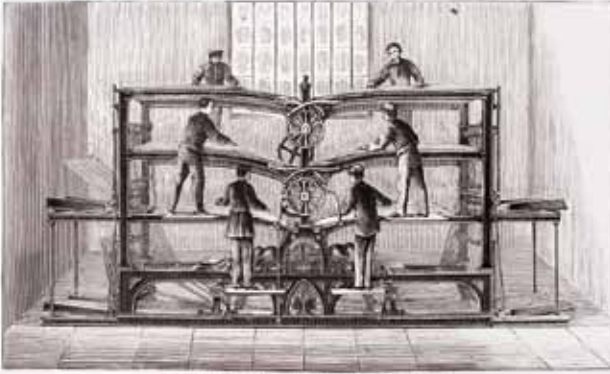

Abzug: Halbtone in der Zeit der ersten Druck- & Buchdruck-Druck



54 Most comprehensive German work on printing published in the 19th century

Waldow, Alexander. Die Buchdruckerkunst in ihrem technischen und kaufmännischen Betriebe. 3 volumes (2 text- and one atlas-volume). Leipzig, Waldow 1874-1877-1875. 4to, chromolithograph title and half-title, [xii], 479, (5), set in blue and green typographical frame with numerous text-illustrations and a few colour printed initials, 3 (2 folding) plates; chromolithograph title and half-title, [vi], 444 pages set in red typographical border, numerous text-illustrations, 19 plates (of which 2 folding and 12 chromolithograph); [vi] text, 66 numb. Wood-engraved plates (8 double-page or folding). Publisher's half calf, richly gilt and embossed front cover with portrait of Gutenberg, bindings expertly restored.

€ 2500.00

Bigmore & Wyman III, 61 (wrong collation of atlas volume). First and only edition of this most comprehensive German work on printing published in the 19th century. The first volume deals with composition, the second contains detailed instructions on printing. This includes chapters on printing equipment with numerous illustrations; colour printing with colour progressive proofs and other chromolithographed specimens; ink with several pages of ink specimens. Also included are specimens of colour map printing and embossed „printing“ for the blind. The atlas volume contains illustrations of German, English, American and French presses. A fine and clean copy. Rare complete set.

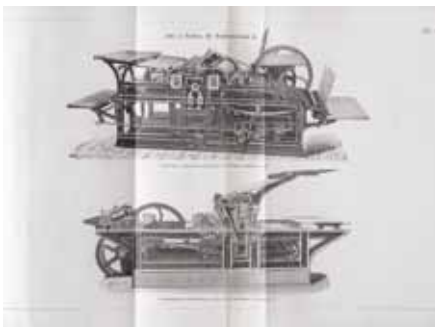
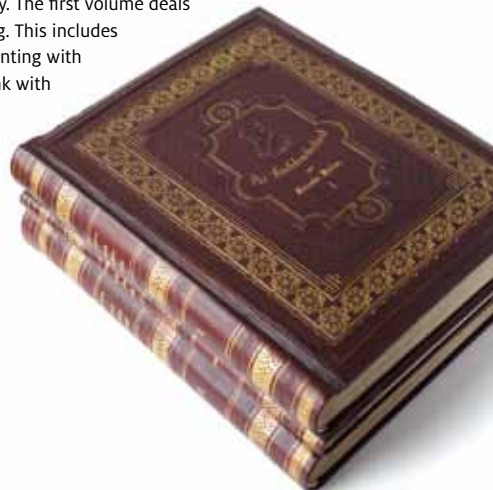



55 Printer's oath

Struck, Johann Hieronymus. Formel nach welcher das deutsche Buchdrucker-Postulat in Stralsund von der dasigen Gesellschaft an zwey geprüfte Liebhaber dieser Kunst am 8ten August 1764 öffentlich ertheilet worden. Stralsund, Hiernonymus Johann Struck (1764). 8vo, pp. 28, stitched as issued, first and last leaf soiled.

€ 550.00

Not in the cat. of the Börsenvereins d. dt. Buchhandels. A very interesting booklet, containing the speeches of various members of the printer's guild in Stralsund to mark the occasion of the integration of Johann Franz Struck (son of Johann Hieronymus) and a certain Johann Carl Friedrich Hennings into the guild of printers. Rare.

56 Colour printing

Bernhard Ullmann & Co. Blattmetall-, Bronzefarben- und Brocat-Fabriken. (Fuerth, Lion's Buch- und Kunstdruckerei 1893). 4to (294 x 234 mm). pp. [iv], 15, with numerous text-illustrations, 2 sample plates with gilt embossed printing. Cloth-backed illustrated boards, silver title on front cover. With loosely inserted gilt printed and folded trade card of this firm (134 x 90 mm), verso with 29 variant colour samples.

€ 600.00

Not in the Internationalen Bibliographie zur Papiergeschichte. A rare and beautifully executed publicity booklet.



57 Industry manual

Hartmann, Carl. Encyklopaedisches Handbuch des Maschinen- und Fabrikenwesens für Kameralisten, Architekten, Künstler, Fabrikanten und Gewerbetreibende jeder Art; Ersten Theiles erste - (dritte) Abtheilung und zweiten Theiles erste - (zweite) Abtheilung. Two parts bound in 5 sections (= all published). Leipzig und Darmstadt, Carl Wilhelm Leske 1838-1839. 4to, pp. viii, iv, iv, 618 columns, viii; xvi columns, 1546 columns. 137 numb. lithograph plates on 112 partly folding leaves (folding plates numbered twice). Publisher's yellow printed boards, covers rubbed and soiled, spines slightly defective.

€ 1200.00

Poggendorff I, 1025. First edition. A first-hand account of industrialization in its various branches. Printing and lithography are described in the second sections of the first part, illustrated with 6 plates (mostly printing and lithographic presses). Text lightly evenly browned, some plates spotted. A nice uncut copy in its original binding.

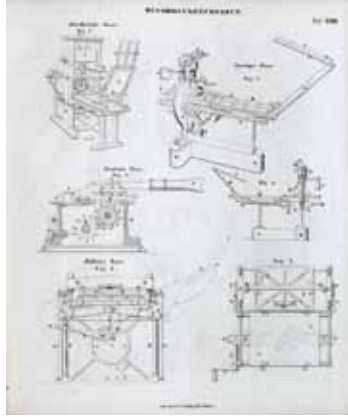

58 Modern printer's marks

Heichen, Paul. Die Drucker- und Verleger-Zeichen der Gegenwart. Mit Voranstellung einiger wichtiger älteren Drucker-Signete. Berlin, Heichen & Skopnik 1892. Oblong- 4to, pp. 36; 94), 28 plates with 398 illustrations of various printer's devices. Publisher's illustrated boards, cloth spine. Slightly soiled.

€ 300.00

First and only edition.



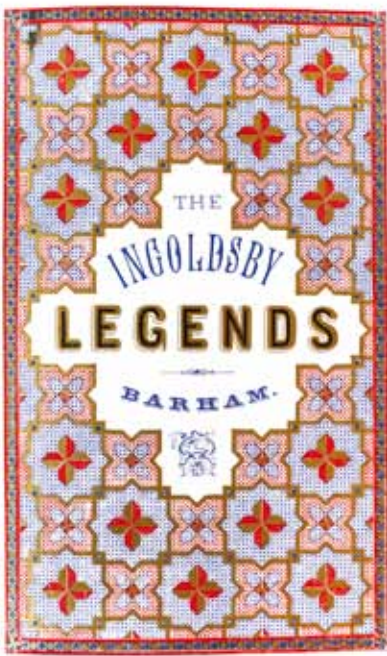

59 'Artistic Printing' for the jobbing printer

Harpel, Oscar H. Harpel's Typograph or Book of Specimens containing useful information, suggestions and a collection of examples of letterpress job printing arranged for the assistance of Master Printers, Amateurs, Apprentices, and others. Cincinnati, the author, 1870. Tall 8vo, colour printed frontispiece, colour printed title, pp. 252, [16] advertiser's addenda, with with in all 22 inserted leaves (of which 12 colour printed, some printed on recto and verso, and some folding); short tears in two folding plates; original gilt-stamped cloth, with title to upper board, edges red, inner hinge strengthened; a good copy.

€ 2900.00

Bigmore & Wyman I, 306; St Bride Catalogue, p. 412; Gray, Nineteenth Century Ornamented Type-Faces, p. 146-150; see David Pankow, The Printer's Manual - An Illustrated History, p. 54. Only edition of a highly influential handbook of printing and type-faces, which catalysed the artistic printing movement in America with an important section on the use of colour. One of the first American sample books for job printers was Oscar Harpel's Typograph, or Book of Specimens, published in Cincinnati in 1870. It was a collection of job work he had produced for all kinds of businesses. The book was printed with great care and precision, and designed with imagination and sensitivity. Although ornate, the results are very attractive today. The book had a strong influence on job printing all over the United States for at least a decade after its appearance, and led to the 'Artistic Printing' style of the late century.

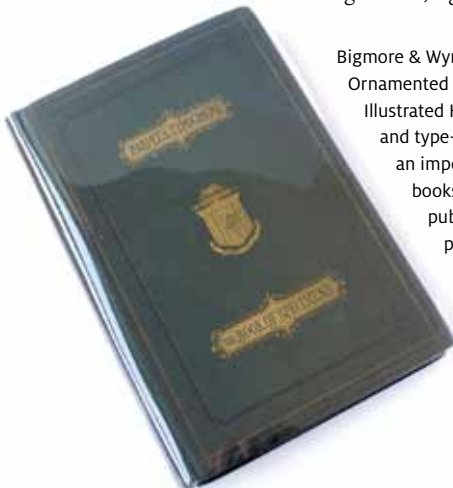



60 Diploma specimens

Förster & Borries. *Musterbuch B. Diplome* (gilt title to front cover). (Zwickau, Förster & Borries, ca 1912). Oblong folio (490 x 360 mm), ll. 54 (folded) with mostly coloured designs for diplomas in various techniques (chromolithograph, collotype, wood engraving) and ll. 2 with ornamental stamps; publisher's printed wrappers; folded in publisher's printed brown cloth portfolio with gilt title to front cover; Covers rubbed.

€ 2400.00

A spectacular specimen book with large designs (up to 600 x 480 mm) for diplomas most of them in bold art nouveau style. A few leaves slightly spotted in margins, a few unobtrusive tears, else remarkably well preserved. Very scarce.



61 The Italian state printing house for cartography

Istituto Geografico. *Campionario dei Caratteri*. Istituto Geografico Militare. Florence, 1934.

€ 720.00

8vo, ll. [60], type specimen printed in black within decorative border printed in sienna; original printed limp boards, a little spotted, else fine. Not found in KVK or OCLC. First edition of this type specimen showing all the type faces, ornaments, borders etc. produced for the Italian Military Geographic Institute (Istituto Geografico Militare), the major state printing house for cartography. It evolved out of the regional topographical offices existing before Italian unification in 1871. A large number of type faces are presented, and illustrated in various sizes and arrangements, using rousing commentary by Mussolini.



62 Commemorative volume with mounted stamp samples

Hirschfeld, Johannes Bernhard. J. B. Hirschfeld. Hundert Jahre einer Leipziger Buchdruckerei. Leipzig, Selbstverlag 1900. Folio (378 x 298 mm), pp. [iv], 61, (1) with numerous partly whole-page text illustrations and manuscript facsimiles, 6 plates in variant techniques (photogravure, chromolithography, wood engraving); publisher's decorated cloth; all edges red. € 500.00

Rare commemorative printing, richly illustrated with sample pages from their publications. A special chapter is devoted to the printing of stamps, illustrated with mounted original samples.



63 Virtuoso display of micro-engraving

Jones, William. Poikilographia, or various specimens of ornamental penmanship comprising twenty two different alphabets. London W. Jones, Private Teacher of Writing, &c., (ca. 1825). Folio, engraved portrait frontispiece, ll. 22 including engraved title and engraved introduction, micro-engraved leaves mostly separated by tissue; some foxing; contemporary half calf over marbled boards, quite worn and upper joint cracked but holding; engraved title label to upper board.

€ 1450.00

64 'Exceedingly rare book relating to the oldest record of papermaking discovered in nature'

Senger, G(erhard). A(nton). Die aelteste Urkunde der Papier-fabrication in der Natur entdeckt nebst Vorschlaegen zu neuen Papierstoffen. Dortmund and Leipzig, Gebr. Malinckrodt 1799. 8vo, pp. 96; original printed wrappers. Wrappers with a few unobtrusive tears in margins. Spine slightly discoloured.

€ 8000.00

Internationale Bibliographie zur Papiergeschichte II, 10598. Weiss, Papiergeschichte p. 222. Hunter p. 46 (with facsimile). Engelmann, Bibl. Mech.-tech. 356. A broadmargined uncut copy. „An exceedingly rare book relating to the oldest record of papermaking discovered in

nature, with proposals for new materials for making paper. The essay is printed on paper fabricated from conferva, a water plant, called by Senger water wool. He stated that water wool, or river paper, was the oldest form of papermaking in nature. This material he termed a coralline product, being the web of water insects, seed capsules, or insects' eggs. Senger discusses the probability of sufficient conferva being found as a substitute for rags in papermaking.“ (Hunter). Old stamp on title else very good.



First edition of Jones' complete guide to penmanship, illustrating a wide variety of styles, alphabets and flourishes, most of them including examples of micro-engraving. The first five plates present various alphabets and their use in dedications, the second half mostly makes use of biblical texts. On the De-calogue plate the entire text of the Ten Commandments is engraved on Moses' two tables, with the English text contained in the Hebrew word. The Lord's prayer is micro-engraved on a small tablet measuring just 10mm across; the letters ,DEUS EST AMOR' are formed entirely out of micro-engraved text from Corinthians 12.



65 With 273 mounted paper samples

Weichelt, August. Buntpapier-Fabrikation. Mit 247 Abbildungen und 273 eingeklebten Mustern. Berlin, Verlag der Papier-Zeitung (1927). 8vo, pp. viii, 448, with 247

text-illustrations, 273 mounted paper samples, publisher's half cloth, gilt title to spine, extremities slightly worn, covers rubbed.

€ 950.00

Herbst, 1791. Cf. Haemmerle p. 194. Third and best edition with many more samples of marbled and fancy papers contained compared to the first edition of 1903 with only 93 samples.



66 Chromatics for the printer

Biering, Wilhelm. Druckfarben, Bindemittel, Trockenstoffe. Kurzgefaßte graphische Farbenkunde für den praktischen Gebrauch. Berlin, Verlag des Bildungsverbandes der Deutschen Buchdrucker 1928. 4to, pp. [x], 34, [4] with 43 mounted colour samples,

illustrated boards, cloth spine; rear cover with small water stain.

€ 400.00

Not in Schießl and in Faber Birren-Collection. Second edition. A concise chromatics for the printer. The first edition of 1926 had been privately issued in only a small number by the Kunstgewerbeschule in Frankfurt.





67 With fifty-four marbling samples

Woolnough, Charles W. *The Whole Art of Marbling as applied to paper, book-edges etc.* containing a full description of the nature and properties of the materials used, the method of preparing them, and of executing every kind of marbling in use at the present time, with numerous illustrations and examples. London, Bell, 1881. 8vo, pp. 82, with one inserted lithograph plate (facsimile letter from Michael Faraday), and 54 specimens of marbled paper, of which twenty mounted on five plates, the remainder full-page; original publisher's green cloth, gilt lettering to spine and to upper board; clumsily rebacked, and inner hinges strengthened; later book-plate to front pastedown; still a good copy.

€ 1950.00

Ph. J. Easton, *Marbling: A History and Bibliography*, p. 178. Second, much enlarged edition of the most important English book on paper marbling. First published in 1853, but with far fewer specimens of marbled paper, the work was also reprinted in 1854. Woolnough gives a very detailed account of the methods and materials of the craft of marbling and gives practical instructions on making thirty-two traditional and ,modern' patterns. He includes information on the stages involved in producing different patterns, all illustrated on the specimen pages, which were produced expressly for the book. Woolnough concludes with instructions on the use of marbled papers in bookbinding, how to marble on vellum or cloth, and how to marble book edges. Until well into the nineteenth century the marbling process had remained a closely guarded secret. Apprentices were taught only separate stages of the craft, not the entire procedure.





68 Pencils & crayons— for office, school and design

Trade catalogue. A.W. Faber Castell-Bleistift-Fabrik A.G. Gegründet 1761, Stein bei Nürnberg. Katalog Ausgabe 1932. Nuremberg, 1932. Folio, pp. 176, xviii, [2], with 3 colour plates, with pp. 16 printed price list inserted in the inside back pocket; original cloth, with Faber Castell company

pattern, post-screw folder. € 980.00

A fine copy of the 1932 trade catalogue of the well-known German pencil & crayon factory, founded in 1761. The well-illustrated catalogue (accompanied by the current price list) shows the full product range, from classic pencils, to polychromos, available in 60 colours to match water-colour paints, erasers, sharpeners etc. All manner of show- and display packs are illustrated, for the office, art & design, science and architecture market. Illustrated product catalogues well designed and printed for the retailers have been a trade mark of the Faber Castell company since the mid- 19th century. 'Never before has a pencil factory issued such a beautifully designed price list, Lothar von Faber proudly wrote to his brother Eberhard in New York, who had moved there to manage a local branch office back in 1849.'

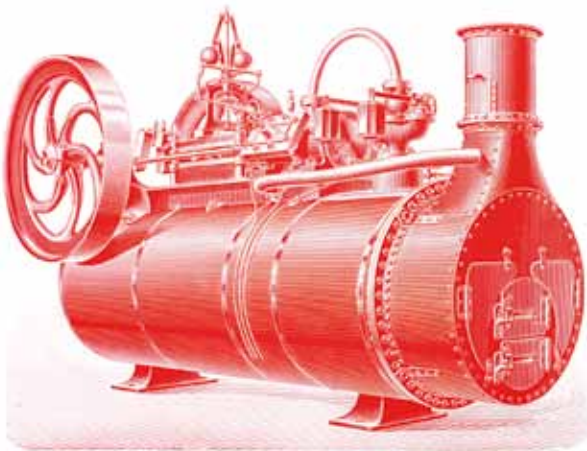

69 Catalogue of printing inks

Prinvaunt, A. Encres Typographiques. Paris, n.d. (but circa 1910?).

€ 900.00

Oblong folio (280 x 224 mm), title, 86 plates with ink specimens on glazed paper, pp. 4 pricelist loosely inserted; publisher's cloth, gilt, all edges red, marbled endpapers, corners bumped. A fine copy.

A. PRINVAULT, Paris.

Requis n° 218



70 Berlingska Boktryckeri- och Stilgjuteri-Aktiebolaget. Stilprof. Lund, privately published (1888-1909). 4to (255 x 190 mm), 2 chromolithograph titles, 5 chromolithograph half titles, 430 unnumbered. leaves, 5 folding plates; richly illustrated publisher's cloth; all edges red.

€ 1200.00

A splendid type specimen with numerous types and ornaments, some of them printed in colours. A fine and fresh copy.

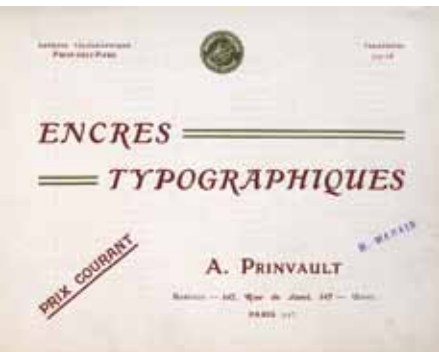



71 Artistic lithography

Duchatel, E. Manuel de lithographie artistique pour l'artiste & l'imprimeur. Préface de Leonce Benedite. Paris, Minot (1907). 4to, pp. [viii], iv, (7)-108, [5], 12 numbered and 11 unnumbered partly chromolithograph plates (13 mounted on china-paper); publisher's illustrated wrappers; front cover with a few small tears in margins.

€ 1100.00

Cf. SMPK (ed.). Ornamentale Vorlagenwerke 2719 (First edition 1893). Enlarged second edition: One of 500 copies. This copy without numbering in colophon. Contains eleven signed lithographs by the following artists: A. Faivre, C. Léandre, L. Métivet, L. Monod, M. Neumont, G. Redon, L. Vallet, A. Willette, P. Maurou, D. Lucas, A. Belleruche und A. Cahard. A fresh and broad margined copy.

72 In-house catalogue with stunning Art Nouveau illustrations

Imprimerie artistique Revellat. (Catalogue de specimens d'imprimerie – Art Nouveau). (Paris, privately published around 1902). Oblong 4to (355 x 252 mm), ll. 82 with 977 monochrome illustrations printed in blue, green red etc. of corners, vignettes, billheads, cartes de visite, trade cards, etc., arranged in manuscript in numerical order; contemporary plain brown cloth, marbled endpapers; spine-ends slightly frayed. € 1500.00

In-house catalogue of this Paris based printing office - 25 quai des Grands Augustins.

A really unusual specimen book emphasizing Art nouveau ornamentation. Contents slightly soiled.





73 One hundred years of Czech lithography

Koranda, V(aclav). Pamětní spis. Vydáný na oslavu sté ročnice vynálezu litografie v Praze 1899. Prague, Haase 1899. 4to, pp. chromolithograph title, 120, (1), numerous illustrations in the text, 18 colour plates printed in various lithographic techniques; publisher's illustrated cloth, slightly soiled.

€ 800.00

First edition. Rare publication to commemorate one hundred years of lithography.





74 Wine labels

Lintz, Jacob. Buch- und Steindruckerei. (Sample book with wine labels). Trier, Jacob Lintz 1925-1933. 4to (210 x 168 mm), ll. [92] blank leaves with ca 370 mounted colour printed and chromolithographed wine labels; publisher's illustrated half cloth with printed name on front cover "Jacob Lintz. Buch- und Steindruckerei. Etikettenfabrik. Trier a.d. Mosel". Edges a little worn. € 450.00

A nice and very well preserved sample book.



75 Sample book with chromos

Rayer, J. [compiler.] Musterbuch von J. Rayer (cover title). No place, no date (Stuttgart, Eckstein & Stähle, ca. 1880-1910). Folio (490 x 330 mm); ll. 88, collection of around 450 mounted chromolithographic prints, various sizes and subjects; contemporary half cloth, front cover with gilt lettering.

€ 2200.00

A fascinating documentation of chromolithographic printing in various fields, probably compiled by an employee of a lithographic office. Included are labels for cigar boxes, billheads, book covers, book illustrations in a great variety of subjects, greeting cards, seed packets, cigarette labels, etc. A few samples removed, a few with marginal surface loss due to sticking together. A fine copy.





76 Chromolithograph wine labels, partly cut-out and embossed
Rau & Blümlein. Lith. Kunst-Anstalt in Frankfurt a. M. Three volumes with mounted wine labels. (Frankfurt, Rau & Blümlein 1857-1865). With altogether over 700 mounted chromolithograph partly embossed labels in various sizes and forms, mostly printed on glazed paper. 4to (320 x 185 mm); contemporary red half leather, gilt name on front cover; and 2 volumes oblong-8vo (130 x 185 mm), contemporary half calf, one spine renewed.

€ 4500.00

A fine and colourful collection of wine labels and a few illustrated trade cards of hotels and pubs. Many of the wine labels with views of the wine-growing villages and small towns, but also phantasy labels partly with gilt embossed frames.

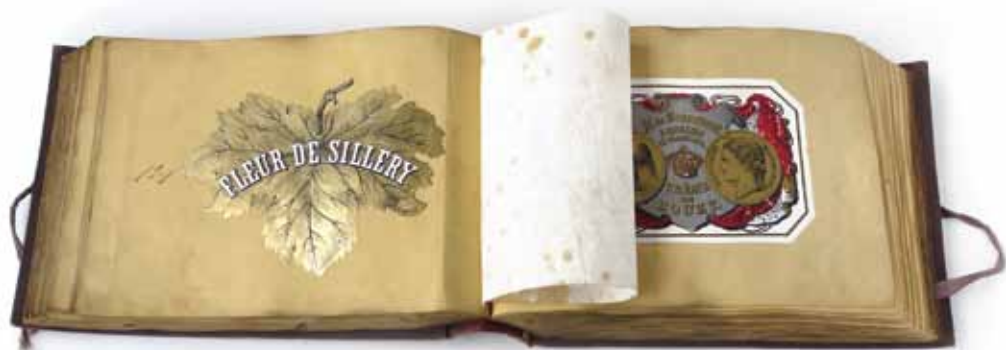



77 Ephemera printing

Buchdruckerei Berichthaus. IV. Internationaler Radiologenkongress Zürich und St. Moritz. 24. – 31. Juli 1934. Archive copy of all the printing carried out for the IV. Congress on radiology held in Zurich and St. Moritz. Zurich, Berichthaus, 1934. Folio (340 x 240 mm), ll. 68 grey board with numerous mounted prints, and three mounted richly decorated brass badges; contemporary half cloth, gilt title to spine in contemporary marbled slip-case. Covers slightly rubbed, else fine. € 500.00

Contains all the printing for this radiologist congress, including a 142 page congress guide.

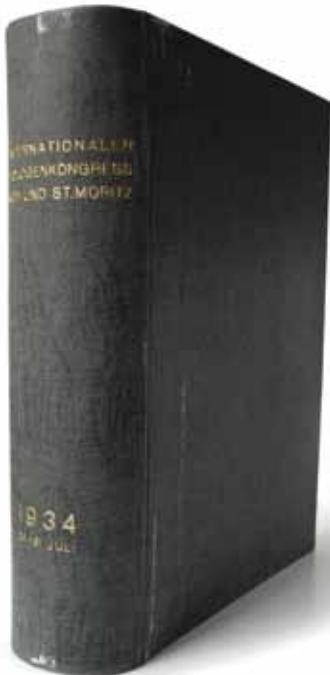



78 Fabulous Art Nouveau colour printing

Elsner, Otto. Buchdruckerei und Verlagsbuchhandlung. Elsnerdruck. Für Freunde guter Druckkunst. Berlin, Elsner, 1914. Folio (465 x 330 mm), ll. [21] with 8 double-page ornamental plates printed in blue, black and silver, and 12 plates with mounted polychrome ephemera, (leaflets, posters, and advertisements) all designed by W. H. Deffke; publisher's cloth; spine with title printed in black; front cover with red trademark designed by Deffke; rear cover with some faint brown spots.

€ 8000.00

Sumptuous commemorative volume of this Berlin based printing and publishing house on the occasion of its 33 years in business. The industrial artist and book designer F. W. H. Deffke (1887-1950) worked from 1909-1910 in the studio of Peter Behrens, and from 1912-1914 for Otto Elsner. "Er gehörte zur Avantgarde der Neuen Typographie und wurde zum Schöpfer eines modernen Typs des Fabrik- und Warenzeichens" (Saur XXV, 181). A fine copy.





Susanne Schulz-Falster
RARE BOOKS

22 Compton Terrace · London N1 2UN
Telephone 0044 · (0)20 · 7704 9845 · sfalster@btinternet.com
www.schulz-falster.com

ANTIQUARIAT BANZHAF

Mömpelgarder Weg 17 · 72072 Tübingen · Germany
Telephone 0049 · (0)7071 · 55 23 14 · Fax 0049 · (0)7071 · 55 23 15
antiquariat-banzhaf@t-online.de · www.antiquariat-banzhaf.de

